

IN3916

IN3900 (SERIES)



Regulatory model: AA0021

InFocus
Bright Ideas Made Brilliant

010-0752-02

InFocus

Declaration of Conformity

Manufacturer: InFocus Corporation, 13190 SW 68th Parkway, Suite 200, Portland, Oregon 97223-8368 USA

We declare under our sole responsibility that this projector conforms to the following directives and norms:

ErP Directive 2009/125/EC

EMC Directive 2004/108/EC

Low Voltage Directive 2006/95/EC

R&TTE Directive: 1999/5/EC

EMC: EN 55022, EN 55024, EN 61000-3-2, EN 61000-3-3

Safety: IEC 60950-1: 2005 (MOD)

ETSI: EN 300 440, EN 301 489

The receiver portion of this product is a Category III device, as specified in EN 300 440.

Trademarks

Apple, Macintosh, and PowerBook are trademarks or registered trademarks of Apple Computer, Inc. IBM is a trademark or registered trademark of International Business Machines, Inc. Microsoft, PowerPoint, and Windows are trademarks or registered trademarks of Microsoft Corporation. Adobe and Acrobat are trademarks or registered trademarks of Adobe Systems Incorporated. DLP®, DLP Link and the DLP logo are registered trademarks of Texas Instruments and BrilliantColor™ is a trademark of Texas Instruments. InFocus, In Focus, and INFOCUS (stylized) are either registered trademarks or trademarks of InFocus Corporation in the United States and other countries.



NOTE: This product is covered electrical and electronic equipment under the European Union's Waste from Electrical and Electronic Equipment ("WEEE") Directive (2002/96/EC). The WEEE Directive requires that covered equipment be collected and managed separately from typical household waste in all EU member states. Please follow the guidance of your local environmental authority or ask the shop where you purchased the product for collection or recycling options.

FCC Warning

This device complies with part 15 of the FCC Rules. Operation is subject to the following two conditions: (1) This device may not cause harmful interference, and (2) this device must accept any interference received, including interference that may cause undesired operation.

Note: This equipment has been tested and found to comply with the limits for a Class B digital device, pursuant to part 15 of the FCC Rules. These limits are designed to provide reasonable protection against harmful interference in a residential installation. This equipment generates, uses and can radiate radio frequency energy and, if not installed and used in accordance with the instructions, may cause harmful interference to radio communications. However, there is no guarantee that interference will not occur in a particular installation. If this equipment does cause harmful interference to radio or television reception, which can be determined by turning the equipment off and on, the user is encouraged to try to correct the interference by one or more of the following measures:

--Reorient or relocate the receiving antenna.

--Increase the separation between the equipment and receiver.

--Connect the equipment into an outlet on a circuit different from that to which the receiver is connected.

--Consult the dealer or an experienced radio/TV technician for help.

Changes or modifications not expressly approved by InFocus Corporation may void authority to operate the equipment.

Canada

This Class B digital apparatus complies with Canadian ICES-003. Cet appareil numérique de la classe B est conforme à la norme NMB-003 du Canada.

Agency Approvals

cTUVus

Other specific Country Approvals may apply. Please see product certification label.

This document applies to regulatory model AA0021.

Input ratings: 100-240Vac, 3.9A, 50-60Hz

InFocus reserves the right to alter product offerings and specifications at any time without notice.

Table of Contents

Introduction	4	Setup menu	33
Positioning the projector	6	Status and Service menu	36
Connecting a computer source	7	Using LitePort	37
USB connection	7	LiteShow	39
VGA connection	7	LiteShow Menu Options	40
Optional computer connections	7	Maintenance	46
Displaying an image	8	Cleaning the lens	46
Adjusting the image	9	Using the security lock	46
Connecting a video device	11	Replacing the projection lamp	47
Video device connections	11		
Composite video connection	11		
VGA connection	11		
Component video connection	11		
LiteBoard™ Wand	12		
Charging the Wand's Battery	12		
How to Use the Wand	12		
Wand Position and Avoiding Shadows	12		
Using More than One Wand	13		
Wand Features	13		
Buttons and Wand Tip	13		
LiteBoard Wand Menu	14		
Troubleshooting LiteBoard	14		
Shutting down the projector	16		
Troubleshooting your setup	16		
Using the remote control	24		
Using the audio	25		
Using the keypad buttons	27		
Optimizing computer images	28		
Presentation features	28		
Optimizing video images	29		
Customizing the projector	29		
Dynamic Messaging	29		
Using the menus	30		
Basic Picture menu	31		
Advanced Picture menu	32		

Important Operating Considerations for Safety

- Refer to this guide for proper startup and shutdown procedures.
- Follow all warnings and cautions in this manual and on the projector.
- Place the projector in a horizontal position no greater than 15 degrees off axis.
- Locate the projector at least 4' (1.2m) away from any heating or cooling vents.
- Do not block ventilation openings. Locate the projector in a well-ventilated area without obstructions to intake or exhaust vents. Do not place the projector on a tablecloth or other soft covering that may block the vents.
- Do not place the projector in direct sunlight, humid, greasy or dusty places or in places where the projector may come into contact with smoke or steam.
- Do not touch or block the projector lens with any objects as this can damage the projector lens. Use the lens cap when the projector is not in use and during transport. Scratches, gouges and other lens damage are not covered by the product warranty.
- Do not look directly into the lens while the projector is being used.
- Do not drop the projector.
- Do not spill liquid on the projector. Spilled liquid may damage the projector.
- Use the power cord provided. Connect the power cord to a receptacle with a protective safety (earth) ground terminal. A surge-protected power strip is recommended.
- Do not overload wall outlets.
- When disconnecting the power cord, hold the plug, not the cord.
- Wash hands after handling the cables supplied with this product.
- The projector remote control uses batteries. Make sure the batteries' polarity (+/-) is aligned correctly. Dispose of used batteries in accordance with local disposal laws.
- Use an InFocus approved ceiling mount kit for proper fitting, ventilation and installation. The warranty does not cover any damage caused by use of non-approved ceiling mount kits or by installing in an improper location.
- When the projector is ceiling mounted, wear protective eyewear to prevent eye injury before opening lamp door.

- Refer all service to qualified service personnel. Servicing your own projector can be dangerous to you and will void the warranty.
- Only use replacement parts specified by InFocus. Unauthorized substitutions may result in fire, electrical shock, or injury, and may void the warranty
- Only genuine InFocus lamps are tested for use in this projector. Use of non InFocus lamps may cause electrical shock and fire, and may void the projector warranty.
- Hg – Lamp contains mercury. Manage in accordance with local disposal laws. See www.lamprecycle.org.
- The projector uses a high-pressure mercury glass lamp. The lamp may fail prematurely, or it may rupture with a popping sound if jolted, scratched, or handled while hot. The risk of lamp failure or rupture also increases as the lamp age increases; please replace the lamp when you see the "Replace Lamp" message.
- In the unlikely event of a lamp rupture, particles may exit through the projector vents. Keep people, food, and drinks out of the "keep out" area under and around the projector, as indicated by the "X" areas below.

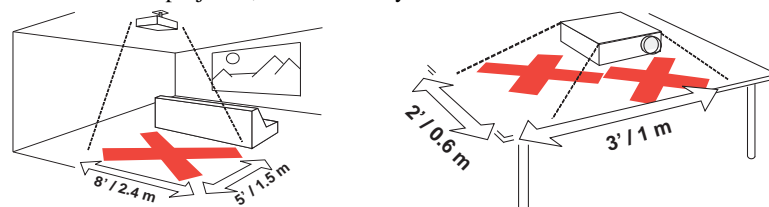

Follow these instructions to help ensure image quality and lamp life over the life of the projector. Failure to follow these instructions may affect the warranty. For complete details of the warranty, see the Warranty Booklet.

Introduction

Your new digital projector is simple to connect, easy to use, and straightforward to maintain. It is a versatile projector that is flexible enough for business presentations and home video viewing too. The IN3916 has native XGA 1024x768 resolution. It is compatible with a wide variety of computers and video devices.

Product specifications

To read the latest specifications on your multimedia projector, be sure to visit our website at www.infocus.com, as specifications are subject to change.

Accessories

The standard accessories that came with your projector are listed in the included Quick Start Poster/Booklet. Optional accessories can be found on our website at www.infocus.com or at your retailer or dealer.

Online registration

Register your projector on our website at www.infocus.com/register to activate your warranty and receive product updates, announcements, and registration incentives.

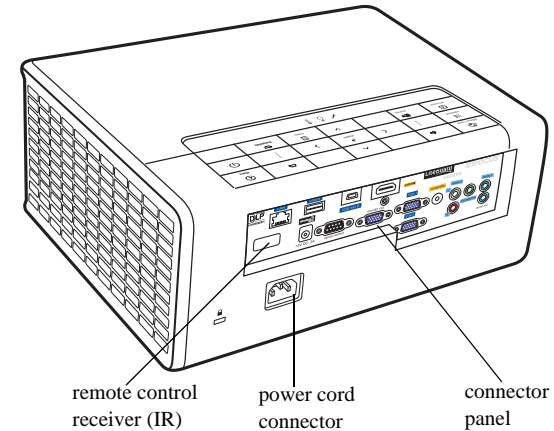
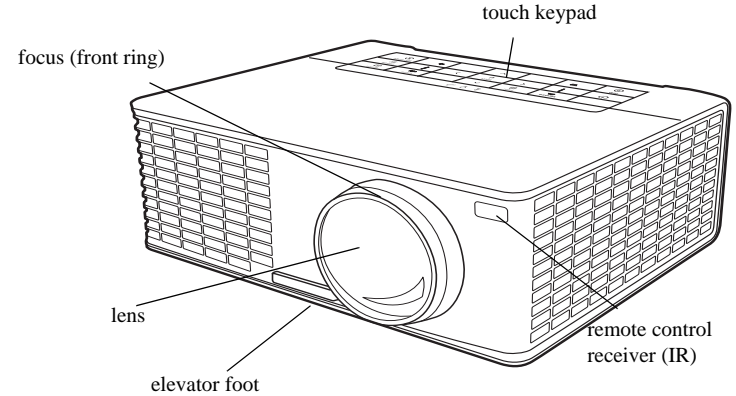

Connector panel

The projector provides both computer and video connection options, including:

- VGA computer
- Composite video
- HDMI
- USB mini B connector. Used for USB Display, slide advance (and mouse control when used with an optional remote control only) and LiteBoard™ Wand control.
- USB A connector. Used for LitePort (JPEG images displayed from USB flash drive) and WLAN.
- Monitor out, for VGA pass through to an external monitor.
- Audio input for video and computer.
- Audio L/R for video and computer.
- Audio output to external speakers.
- Microphone, for connecting to a dynamic microphone.
- LAN (RJ45) connector for network control and web server.
- Serial Control (DB9) connector for RS-232 serial control. Command control codes are on our support website at www.infocus.com/support.
- 5 volt DC output. The coaxial connector accepts a 2.1mm x 5.5mm plug and provides a constant 5 volt, 2 amp DC output when the projector is on. It is designed to provide power for an InFocus LiteShow wireless device, which allows wireless projection. More information can be found on our website at www.infocus.com or at your retailer or dealer.

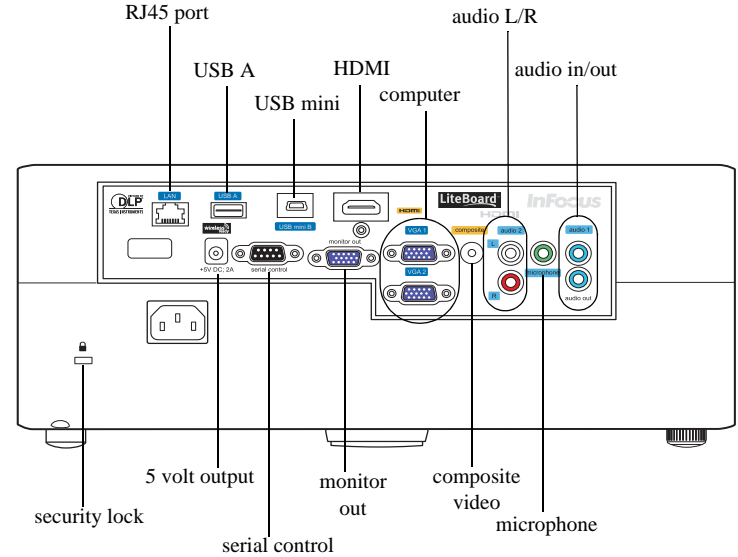

Positioning the projector

To determine where to position the projector, consider the size and shape of your screen, the location of your power outlets, and the distance between the projector and the rest of your equipment. Here are some general guidelines:

- Position the projector between 30 inches (.75m) and 65 inches (1.65m) from the screen. To ensure adequate cable access, do not place the projector within 24 inches (.61m) of a wall or other object.
- If you are installing the projector on the ceiling, we strongly recommend using InFocus approved ceiling mounts for proper fitting, ventilation and installation. Refer to the installation guide that comes with the InFocus Ceiling Mount Kit (p/n SP-CEIL-UNIV) for more information. The warranty does not cover any damage caused by use of non-approved ceiling mount kits or by installing in an improper location. To turn the image upside down, see “Ceiling mount” on page 34. We recommend using an InFocus authorized ceiling mount.
- Position the projector the desired distance from the screen. The distance from the lens of the projector to the screen and the video format determine the size of the projected image. (The throw ratio of the IN3916 is 0.49:1.)
- IN3916 image offset is 105% +/-2%. This means that if you have an image 40 inches (1 meter) tall from a table-mounted projector, the bottom of the image will be 2.8 inches (.07 meter) above the centerline of the lens.

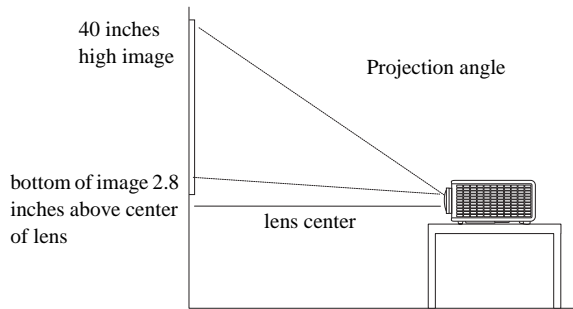

Table 1: Screen Size

Diagonal Screen Size		Size of the Projected Image Width			Projection Distance (L) Minimum	
Feet	Inches	Meters	Inches	Milimeters	Meters	Inches
5.9	71	1.8	60	153	0.75	30
6.7	80	2.0	68	172	0.84	33
7.5	90	2.3	76	194	0.95	37
7.8	94	2.4	80	202	0.99	39
8.3	100	2.5	85	215	1.05	41
8.7	104	2.6	88	224	1.10	43
10.0	120	3.0	102	258	1.26	50
13.0	156	4.0	133	337	1.65	65

Connecting a computer source

USB Mini B connection

Connect the USB cable to your computer's USB A connector and to the projector's USB mini B connector.

To display images over USB: If this is the first time you have used the USB Display feature, an Auto-Play screen will appear within a minute. Click Start USB Display. (Note: If the Auto-Play screen does not appear, browse to the CD Drive USB Display on your computer and double-click the DLUSB.Cab file to initiate manually.)

Within a minute, your computer image should display.

To stop displaying your computer image over the USB cable: Disconnect the USB cable from the projector and/or laptop or change the selected source on the projector.

To advance slides in a PowerPoint presentation using the remote control: Press the up and down arrow buttons on the remote control to move through your slides.

VGA connection

Connect one end of the provided computer cable to the **VGA 1/VGA 2** connector on the projector and the other to the VGA connector on your computer. If you are using a desktop computer, you will need to disconnect the monitor cable from the computer's video port first.

HDMI 1.3 connection

HDMI is a standard, uncompressed, all-digital audio/video interface. HDMI provides an interface between sources, such as set-top boxes, DVD players, and receivers and your projector. Plug an HDMI cable into the video-out connector on the video device and into the HDMI connector on the projector.

To take advantage of HDMI 1.3 Deep Color (30 bit), you must have a 1.3-compatible source.

Connecting power

Connect the black power cord to the **Power** connector on the rear of the projector and to your electrical outlet. The Power light on the Status Indicator Panel (page 16) turns amber. **NOTE:** Always use the power cord that shipped with the projector.

Optional computer connections

To get sound from the projector, connect an audio cable (optional cable, not included) to your computer and to the **Audio 1** connector on the projector. You may also need an adapter.

To display a presentation using a USB flash drive, see the Using LitePort (page 37). This feature displays JPEG images and Presentation-to-Go presentation, eliminating the need for a computer source.

If you are using a desktop computer and want to see the image on your computer screen as well as on the projection screen, connect the computer's monitor cable to the **Monitor Out** connector on the projector.

connect USB cable

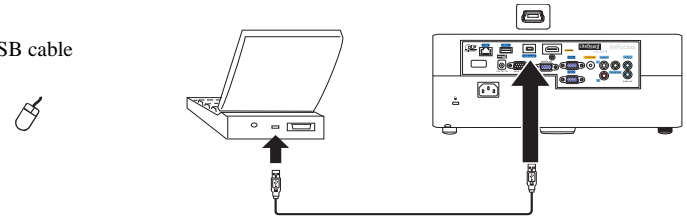

connect VGA cable

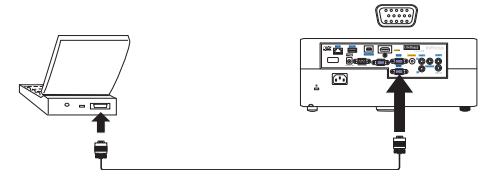

Displaying an image

Touch the **Power** button.

The Power button blinks green and the fans start to run. When the lamp comes on, the start up screen displays and the Power button is steady green. It can take up to a minute for the image to achieve full brightness.

? No start up screen? Get help on page 17.

Turn on your computer or video device.

The image should appear on the projection screen. If it doesn't, press the **Source** button on the projector's keypad or remote.

If you are using a VGA cable to connect your computer to the projector:

If using a laptop, make sure its external video port is active.

Many laptops do not automatically turn on their external video port when a projector is connected. Usually a key combination like FN + F8 or CRT/LCD key turns the external display on and off. Locate a function key labeled CRT/LCD or a function key with a monitor symbol. Press FN and the labeled function key simultaneously.

Refer to your laptop's documentation for more information about your laptop's key combination or go to the InFocus website at: <http://www.infocus.com/Support/LaptopActivation.aspx>.

? No laptop image? Try pressing the **Auto Image** button on the keypad. Get help on page 17.

press Power button

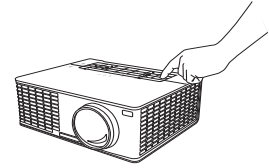

turn on computer or video device

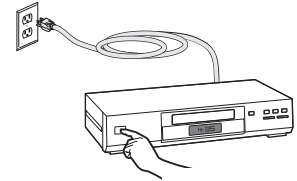
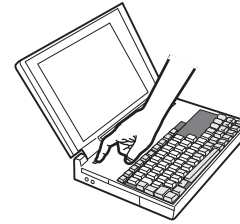

activate laptop's external port



monitor key or
LCD/CRT key



FN key



Adjusting the image

If necessary, adjust the height of the projector by pressing the elevator foot release button to extend the foot.

If necessary, rotate the leveling foot located at the rear of the projector.

Avoid placing your hands near the hot exhaust vent at the front of the projector.

Position the projector the desired distance from the screen at a 90 degree angle to the screen.

See page 6 for a table listing screen sizes and distances.

Adjust the focus.

If the image is not square, first make sure that the projector is perpendicular to the screen. If the image is larger or smaller on the top or bottom edge of the screen, press the top **Keystone** button to reduce the upper part of the image, and press the bottom **Keystone** button to reduce the lower part.

If the left or right side of the screen is larger or smaller the other, you can turn the projector to the left or to the right a few degrees to square the image.

Adjust the Contrast or Brightness in the Basic Picture menu. See page 31 for help with these menu adjustments.

For Aspect Ratio, keep in mind that DVD players must be configured for 16:9 in order to view the highest quality image. For more information regarding Aspect Ratio, see page 10.

adjust height

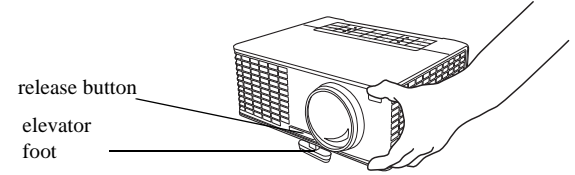

adjust distance

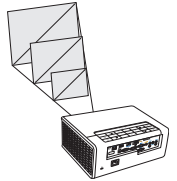

adjust focus

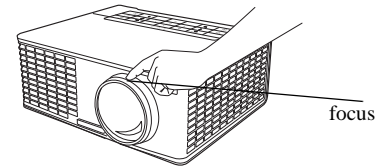

adjust keystone

keystone

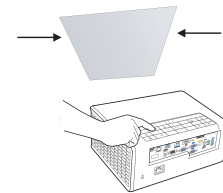

adjust Basic Picture menu

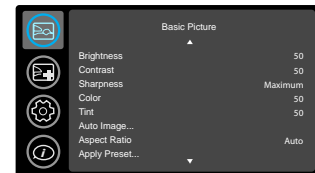

What is Aspect Ratio?

Aspect ratio is the ratio of the image width to image height. Depending on your source, you will want to choose the aspect ratio (using your projector remote or keypad) which matches your source.

Older TV screens and laptops are 4:3; newer TV screens, HDTV and most DVDs are 16:9; and widescreen computers are 16:10.

Use an aspect ratio of 16:9 for widescreen movies and HDTV, and use Native for 4:3 content. Force Wide can also be enabled to automatically resize less common aspect ratios to 16:10.

4:3 screen

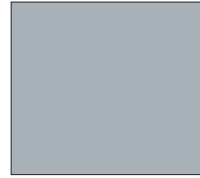

16:10 screen



4:3
mode



16:10
mode



Native
mode

Connecting a video device

You can connect video devices such as VCRs, DVD players, camcorders, digital cameras, video game consoles, HDTV receivers, and TV tuners to the projector. You can connect the audio directly to the projector to get sound from the built-in speaker, or you can bypass the projector's audio system and connect the audio directly from your source to a stereo or home theater system.

You can connect the projector to most video devices that can output video. You cannot directly connect the coaxial cable that enters your house from a cable or satellite company, the signal must pass through a tuner first. Examples of tuners are digital cable boxes, VCRs, digital video recorders, and satellite TV boxes. Basically, any device that can change channels is considered a tuner.

Before connecting your projector, you should decide which aspect ratio you want to use. The projector's Aspect Ratio setting is accessed through the Resize button on the remote or through the projector's Basic Picture Menu. See page 31 for more information.

Video device connections

No video cables are provided with the projector. You can order cables from InFocus or provide your own.

HDMI 1.3 connection

HDMI is a standard, uncompressed, all-digital audio/video interface. HDMI provides an interface between sources, such as set-top boxes, DVD players, and receivers and your projector. Plug an HDMI cable into the video-out connector on the video device and into the HDMI connector on the projector.

To take advantage of HDMI 1.3 Deep Color (30 bit), you must have a 1.3-compatible source.

Composite video connection

Plug the composite video cable's yellow connector into the video-out connector on the video device. Plug the other yellow connector into the yellow **Video** connector on the projector.

If your source uses RCA connectors, connect the red audio-out connector on the audio source to the red audio-in connector on the projector and white audio-out connector on the audio source to the white audio-in connector on the projector.

If your source uses a 3.5mm stereo connector, connect it to the 3.5mm audio-in connector on the projector.

VGA connection

If your video device has a 15-pin VGA output, plug one end of the included computer cable into the VGA connector on your video source. This connector may be labeled "To Monitor" on the video source. Plug the computer cable into the **VGA** connector on the projector.

Component video connection

If your HD video device has component connectors, an optional Component to VGA adapter can be used. Plug the component cable into the video device. Plug the other end of the component cable into the adapter and plug the adapter into the **VGA** connector.

LiteBoard™ Wand

The LiteBoard Wand works like a wireless mouse - but one that works in midair, not on your desktop. Just hold the wand in your hand, and point it at the projected image to point, click and drag. The wand works with all your software, just like a regular mouse.

Charging the Wand's Battery

When the wand's amber battery light starts to blink, its internal battery is low (if the battery is fully discharged, you won't be able to turn the wand on by pressing its tip, left or right buttons).

To charge the battery, open the flap at the bottom of the wand to expose the wand's USB connector. Then connect a USB cable between the wand and the USB power adapter, or a computer (if connecting to a computer, make sure the computer is powered on). The battery light will stay on while the battery is charging, then it will turn off when the battery is fully charged.

When charging is finished, you can disconnect the USB cable (or keep the cable connected and use the wand while it's charging).

NOTE: 5-10 minutes of charging is enough for about an hour of wand use. A full charge will take 6-8 hours and will allow 20-40 hours of non-stop wand use. A fully charged, new wand will hold a charge in standby for up to 3 weeks.

Caution: The lithium battery is only rechargeable, and is not user serviceable or user replaceable.

Caution: Always use the included USB cable and power adapter (or your computer) to charge the wand.

How to Use the Wand

- 1 The IN3916 projector needs to be powered on and connected to your computer.
- 2 Connect the projector and your computer with a USB cable.
- 3 Connect the projector and your computer with a VGA cable.
- 4 Make sure the wand's battery is charged or charging.
- 5 Turn on the projector and make sure it's displaying the computer's screen - set

the source to VGA 1 or VGA 2 (press the source button on the projector or its remote if needed - you may need to press it several times).

- 6 Turn on the wand by pressing its tip, left or right button - the wand's blue status light will start to blink.
- 7 Point the wand at the screen to point, click, and drag - just like a normal mouse. The Undo button is located at the bottom of the wand. You can define this button in the LiteBoard Wand Menu.

NOTE: See LiteBoard Wand Menu below for settings that let you fine-tune wand motion and clicking behavior. When you're done, set the wand aside and make sure it isn't pointing at the screen; it will turn itself off automatically after 1 minute.



Wand Position and Avoiding Shadows

Your Location Distance from the Screen

You can use the LiteBoard Wand right up against the screen, or around the room. You might find that your pointing accuracy will improve if you get closer to the screen. Also, avoid standing too far off from either side of the screen.

Avoid Shadows!

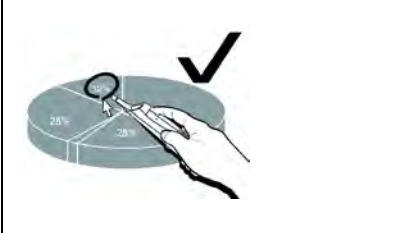
The wand won't work if its sensor is in a shadow or if it is pointing at a shadow:

Correct (no shadow)	Incorrect (shadow)
	

How to Hold the Wand

You can hold the wand the way you would hold a normal pencil or pen, or you can hold it like a remote control - use in whichever position is most comfortable.

NOTE: If the wand is up close to the screen, you can press its tip against the projection surface to click and drag. Not recommended for use with fabric screens.

Using More than One Wand

The projector can work with more than one wand, but you can only use one wand at a time. When you want to switch to a different wand:

- 1 Point the current wand away from the projected image for at least 3 seconds.
- 2 Press the tip, left or right button on the new wand to turn it on, and then start using the new wand.

NOTE: Settings in the projector's LiteBoard Wand menu (see below) apply to all wands used with that projector.

Wand Features

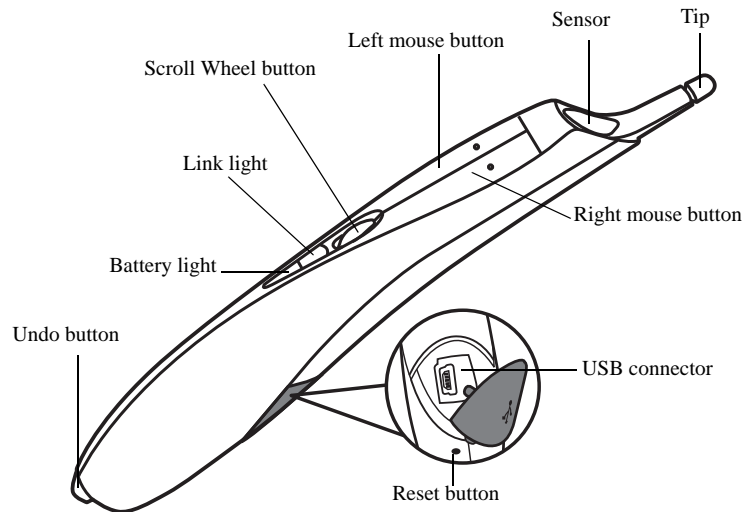

Buttons and Wand Tip

The wand's three top buttons are equivalent to the left, right, and scroll wheel buttons on a mouse. The wand's tip is also a button, and is equivalent to the left mouse button.

NOTE: By default, the Scroll Wheel button changes wand motion between **Auto**, **Normal** and **Draw**. **Auto** switches between **Draw**, **Normal** and **Stable** mode depending on the image size and distance. **Normal** makes clicking easier, but **Draw** allows smoother motion. You can change the Scroll Wheel button to perform other functions, including a standard middle button mouse click (see LiteBoard Wand Menu below).

Battery Light

The amber battery light shows the status of the wand's built-in battery (see below for battery information). The battery light will turn on while the wand is charging, and it will blink if the battery is low (2-4 hours of wand use left).

Link Light

The blue link light shows the status of the wand's wireless connection to the projector. The link light will blink frequently (more than once per second) when the wand is attempting to link to the projector; then it will blink less frequently (about once every 4 seconds) after the wand has linked to the projector.

NOTE: The link light will stay off when the wand is off.

USB Connector

The wand's USB connector is behind a flap on the back of the wand. The USB connector is only used for charging the wand's battery - using the included USB power adapter, or a computer.

NOTE: You can use the wand while charging the battery, but after the battery is charged (battery light turns off), you can unplug the USB cable and continue to use the wand without a cable.

Undo Button

The wand's Undo button will function the same as the computer's Escape, Delete, or Backspace buttons, or the same as a Ctrl+Z (Windows/Linux) or Cmd+Z (Mac OS) command, depending on which function you assign to it in the LiteBoard Wand menu.

Sensor

The wand's optical sensor opening is located above the wand's tip. Don't block the sensor, and make sure it always has a clear view of the screen.

NOTE: The sensor won't work if you point it at a shadow or away from the screen.

Reset Button

The wand has a reset button, behind a small hole on its underside. Under normal conditions, you should not need to reset the wand. See the Troubleshooting section below for more information.

Internal Radio

The wand has a built-in wireless transmitter/receiver which it uses to communicate with the projector.

Lithium Battery Information

Manufacturer: HiTech Energy Inc.

Model: E3BE105K1002

Rating: 3.7V/800mAh

Caution: Lithium battery is only rechargeable, and not user replaceable. Not user serviceable.

LiteBoard Wand Menu

You can access the LiteBoard Wand menu from the projector's **Setup** menu. To change the settings in this menu, highlight a setting, then press **Select** (on the projector or its remote) one or more times - each press of **Select** will change to the next value for the setting.

Enabled: controls whether the projector lets you use LiteBoard Wands. Set this to **Yes** to allow wand use. Set this to **No** to prevent wand use.

Motion: controls wand motion. When set to **Auto**, the motion mode will switch between **Normal**, **Draw** and **Stable** depending on the image size and distance. When set to **Normal**, motion is set up to work best for normal computer use. When set to **Draw**, motion is set up to work best for on-screen drawing. When set to **Stable**, motion is filtered for maximum stability. When set to **Press to Move**, the mouse pointer only moves when you hold down the wand's tip or the left button on the wand (use the right button to click).

Click Speed: controls the motion pause when you click and only applies if Motion is set to **Normal** or **Stable**. Longer click speeds will make it easier to double-click, but will increase the delay before motion resumes after you click.

Scroll Button Mode: selects the function of the wand's Scroll Wheel button. You can use the Scroll Wheel button to change wand motion, or perform keyboard or mouse button shortcuts.

NOTE: The **PwrPnt Annotate** setting sets up the Scroll Wheel button to control drawing (annotating) during Microsoft PowerPoint slide shows. The first press of the Scroll Wheel button will turn on the drawing function, the next press will turn off the drawing function, the next press will turn it on again, etc.

Undo Button: selects the function of the wand's undo Button.

Link Channel: selects the radio channel used for wand communication. This should be set to **Auto** unless you encounter interference (see Troubleshooting below for more information).

Troubleshooting LiteBoard

For the most up-to-date information, visit our support site at www.infocus.com/support

- If the wand doesn't work at all, or it works intermittently, try one of these solutions:
 - **Press to Move** may be enabled; try holding down one of the wand's buttons while moving the wand.
 - Press the tip, left or right button on the wand to turn it on.
 - If the wand's blue Link light never blinks, then the wand's battery is fully discharged; connect the wand to the USB power adapter or your computer.
 - Make sure the wand is not pointing at a shadow and make sure its tip is not in a shadow.
 - If the room is brightly lit, reduce the room illumination.
 - If you're trying to use the computer's mouse at the same time as the wand, point the wand away from the screen while using the mouse.
 - If someone else is using a different wand with the same projector, they must stop using it before you can use another wand.
 - Change the **Link Channel** value in the **LiteBoard Wand** menu.
 - Reset the wand: push the end of a paper clip into the reset opening on the underside of the wand.
- If accurate clicking is difficult, try one of these solutions:
 - Hold the wand steadier when clicking.
 - Use the wand right up against the screen so it's easier to avoid unexpected movements.
 - Change the **Motion** value in the **LiteBoard Wand** menu.
- If it is difficult to draw or move freely because the wand wants to move in straight lines or draw extra lines, try changing the **Motion** value in the **LiteBoard Wand** menu.

- If the mouse pointer is in the wrong place on the screen, or the mouse pointer's movement is restricted to only part of the screen, try one of these solutions:
 - Make sure your projector is displaying the computer's screen and not some other source (such as DVD, VCR, etc.). To change the source, press the Source button on the projector or its remote.
 - Make sure the projector is displaying the same image as the computer's main or built-in monitor (don't extend your desktop onto multiple monitors). To correct this:
 - On Windows XP: Open the Display control panel, click Settings, click the display that represents the projector, then un-check "Extend my Windows desktop...".
 - On Windows Vista: Right-click on the desktop, choose Personalize..., click Display Settings, click the display that represents the projector, then un-check "Extend the desktop..."
 - On Windows 7.0: Right-click on the desktop, choose Screen Resolution, click the display that represents the projector, and then choose the "Duplicate Display..." under Multiple Displays.
 - On Macintosh: Select System Preferences from the Apple Menu, then select Displays. Click Arrangement, and check "Mirror Displays."
- If the battery light does not turn on when the wand is being charged, try one of the following:
 - Make sure a USB cable is connected between the wand and either the USB power adapter, or a USB port on your computer.
 - If the wand is connected to the USB power adapter, make sure the adapter is plugged in to a live electrical outlet. If the wand is connected to your computer, make sure the computer is powered on.
 - If the wand still won't charge, contact InFocus support at: www.infocus.com/support.

Shutting down the projector

Screen Save Time

You can make the black screen appear after a preset number of minutes by turning on the Screen Save Time feature in the Setup menu. See page 33.

Auto Off Time

The projector also has an Auto Off Time feature that automatically turns the projector off after no active sources are detected and no user interaction with the projector is performed for 30 minutes. By default, this feature is off. You can change the length of time, see page 33.

Turning off the projector

To turn the projector off, press the **Power** button on the remote or keypad. The lamp turns off and the LED blinks amber for 1 minute while the fans continue to run to cool the lamp. When the lamp has cooled, the LED lights amber and the fans stop. Unplug the power cable to completely power off the projector.

Troubleshooting your setup

If your image appears correctly on the screen, skip to the next section. If it does not, troubleshoot the setup.

The Status Indicator Panel on top of the projector indicates the state of the projector and can help you troubleshoot.

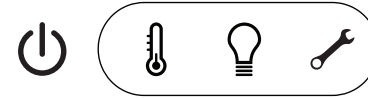



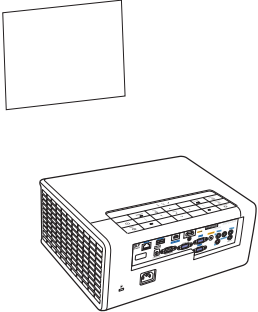
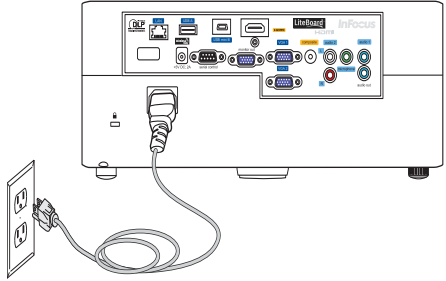
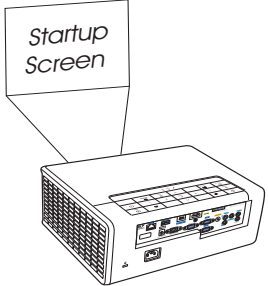
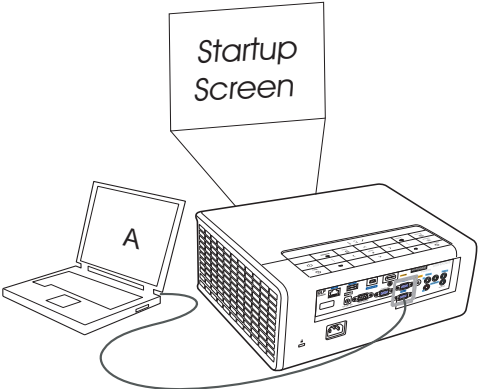

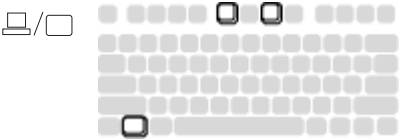
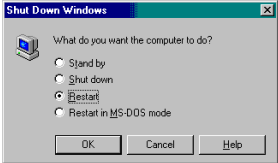
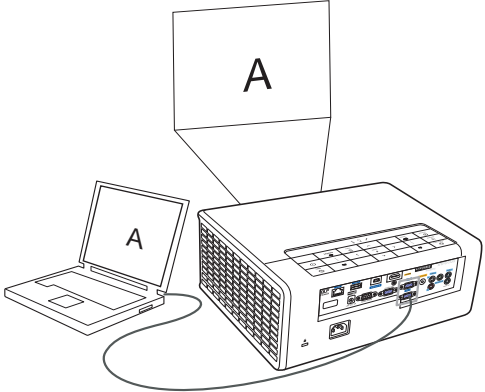
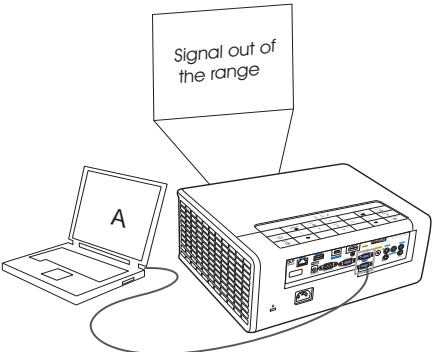
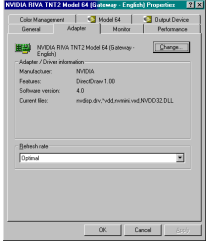
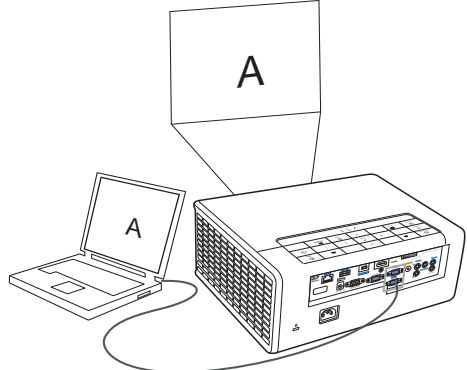
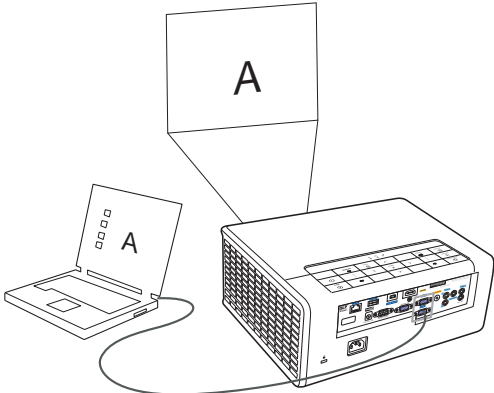

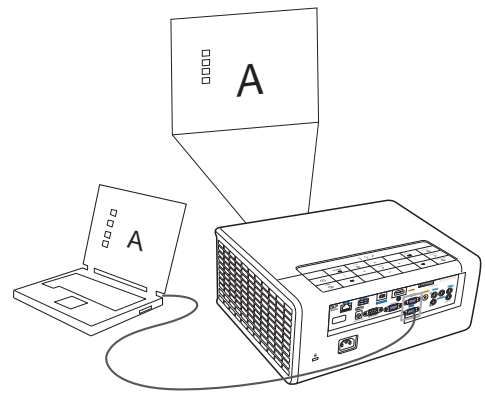
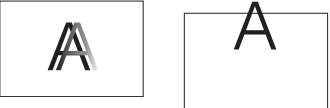

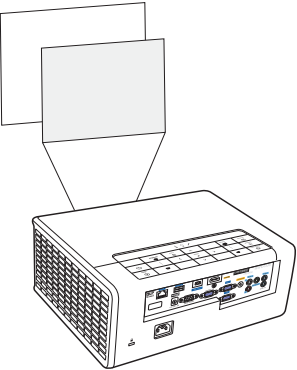
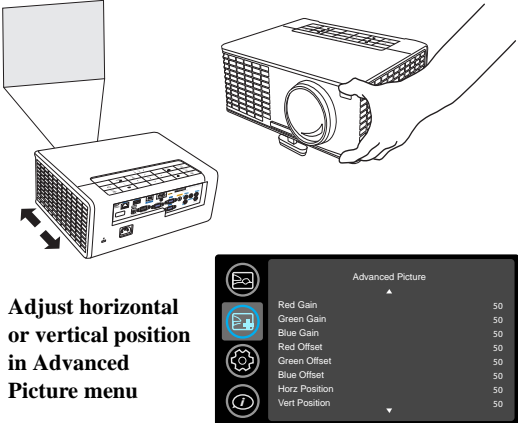
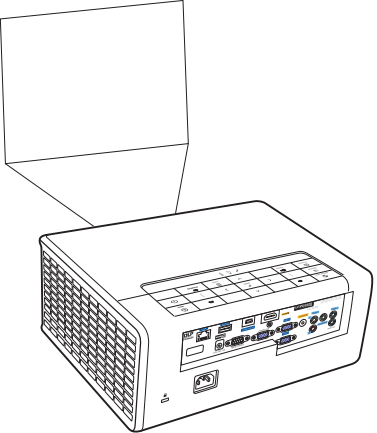

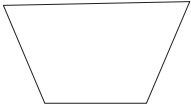
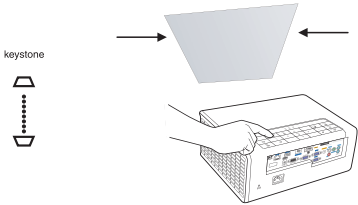

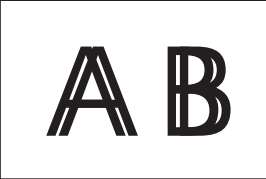





Table 2: Status indicator light behavior and meaning







Power, solid amber 	The projector is plugged in.
Power, blinking green	The power button has been pressed and the software is initializing.
Power, solid green	The projector is on and initialized.
Power, blinking amber	The power button has been pressed to turn the projector off and the fans are running to cool the projector.
Thermometer 	The projector is too hot. Make sure the vents aren't blocked (see page 22). Turn off the projector and wait one minute, then turn the projector on again. Contact Technical Support if the problem persists. Visit www.infocus.com/support to contact service.
Lamp 	Turn off the projector and wait one minute, then turn the projector on again. If the lamp light turns on again, replace the lamp and reset the lamp timer.
Wrench/Service 	Turn off the projector and wait one minute, then turn the projector on again. If the service lamp turns on again, service is required. Visit www.infocus.com/support to contact service.

Problem	Solution	Result
<p data-bbox="48 115 244 141">No start up screen</p> 	<p data-bbox="661 115 1025 169">Plug power cord into the projector press power button</p> 	<p data-bbox="1183 115 1340 141">Correct image</p> 
<p data-bbox="48 502 354 528">Only start up screen appears</p> 	<p data-bbox="661 502 977 556">Press the Source button  activate laptop's external port</p>  <p data-bbox="678 862 822 887">Restart laptop</p> 	<p data-bbox="1183 502 1468 528">Computer image projected</p> 

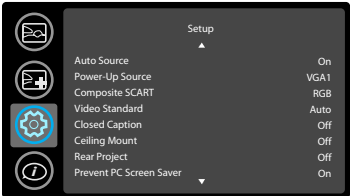
Problem	Solution	Result
<p data-bbox="48 137 564 195">No computer image, just the words “Signal out of range”</p> 	<p data-bbox="604 126 1128 235">Press the Auto Image button on keypad Adjust computer refresh rate in Control Panel > Display > Settings > Advanced > Adapter (location varies by operating system)</p>  <p data-bbox="604 487 1128 574">You may also need to set a different resolution on your computer, as shown in the following problem, “image fuzzy or cropped”</p>	<p data-bbox="1182 132 1466 160">Computer image projected</p> 
<p data-bbox="48 602 529 660">Only my laptop’s background appears, not the Desktop icons</p> 	<p data-bbox="604 596 1154 677">Disable “Extend my Windows Desktop” in Control Panel > Display > Settings > Display 2 (location varies by operating system)</p>  <p data-bbox="616 964 746 1044">Uncheck this option, then click Apply</p>	<p data-bbox="1182 608 1553 637">Background and Desktop projected</p> 

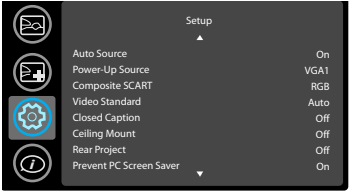
Problem	Solution	Result
<p data-bbox="48 89 296 115">Image fuzzy or cropped</p> 	<p data-bbox="604 87 1152 167">Set your computer's display resolution to the native resolution of the projector (Start > Settings > Control Panel > Display > Settings tab)</p> <p data-bbox="656 307 821 437">For a laptop, disable laptop monitor or turn-on dual-display mode</p> 	<p data-bbox="1182 89 1477 115">Image clear and not cropped</p> 
<p data-bbox="48 544 352 570">Image not centered on screen</p> 	<p data-bbox="604 540 909 567">Move projector, adjust height</p>  <p data-bbox="656 873 840 976">Adjust horizontal or vertical position in Advanced Picture menu</p>	<p data-bbox="1182 540 1329 567">Correct image</p> 

Problem	Solution	Result
<p data-bbox="48 97 234 120">Image not square</p> 	<p data-bbox="604 97 894 120">Adjust Keystone on keypad</p> 	<p data-bbox="1182 97 1328 120">Square image</p> 
<p data-bbox="48 351 222 374">Image not sharp</p> 	<p data-bbox="604 351 1055 374">Adjust Sharpness in the Basic Picture menu</p> 	<p data-bbox="1182 351 1333 374">Correct image</p> 
<p data-bbox="48 638 425 661">Image does not fit 4:3 or 16:9 screen</p> 	<p data-bbox="604 638 1041 695">Change aspect ratio to 4:3 or 16:9 in Basic Picture>Aspect Ratio menu</p> 	<p data-bbox="1182 632 1333 655">Correct image</p> 

Problem	Solution	Result
<p>Image upside down</p> 	<p>Turn off Ceiling Mount in Setup menu</p> 	<p>Correct image</p> 
<p>Image reversed left to right</p> 	<p>Turn off Rear Project in Setup menu</p> 	<p>Correct image</p> 
<p>Projected colors don't match source</p> 	<p>Adjust Color, Tint, Brightness, Contrast in the Basic Picture menu</p> 	<p>Correct image</p> 

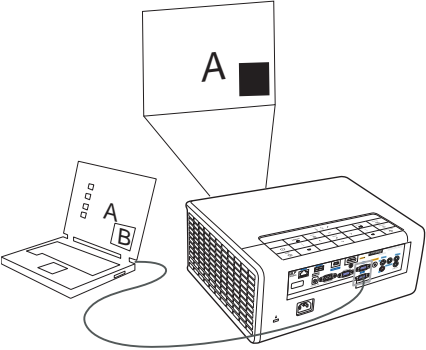
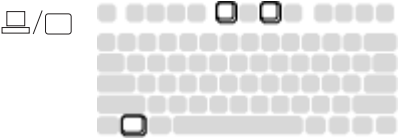
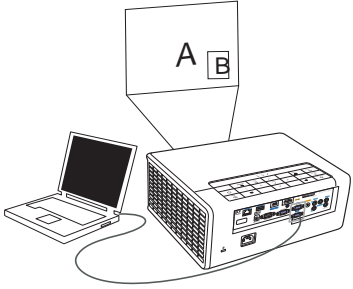
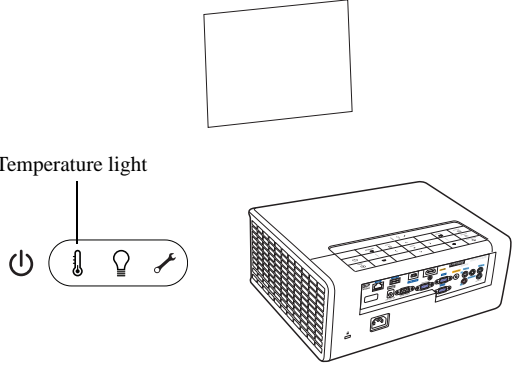
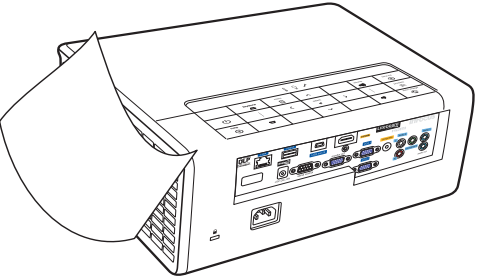
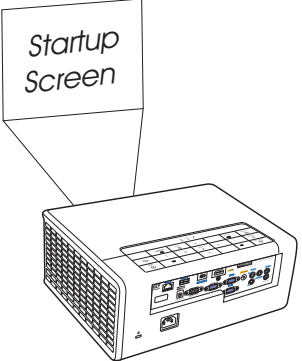
Problem	Solution	Result
<p data-bbox="48 101 465 153">The video embedded in my PowerPoint presentation does not play on the screen</p> 	<p data-bbox="604 101 1112 123">Turn off the internal LCD display on your laptop</p> 	<p data-bbox="1182 101 1517 123">Embedded video plays correctly</p> 
<p data-bbox="48 547 517 570">Lamp won't turn on, Temperature light is on</p> 	<p data-bbox="604 547 1152 593">Make sure vents aren't blocked, turn off the projector and allow it to cool for one minute</p> 	<p data-bbox="1182 547 1343 570">Lamp turns on</p> 

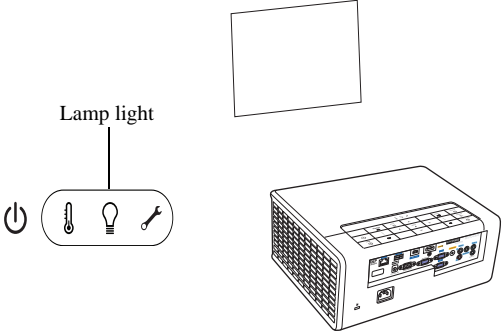
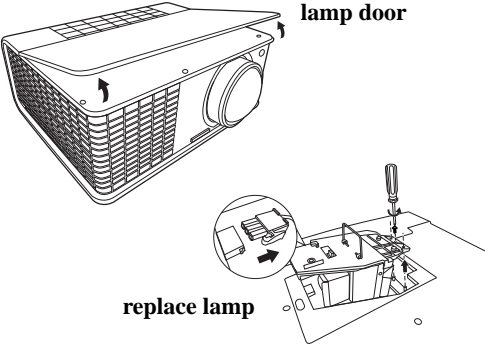
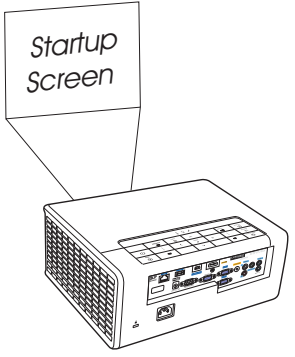
Problem	Solution	Result
<p data-bbox="48 101 569 154">“Replace lamp” message appears at startup, lamp won’t turn on, Lamp light is turned on</p> 	<p data-bbox="604 106 986 132">Lamp must be replaced (see page 47)</p> 	<p data-bbox="1182 95 1338 120">Lamp turns on</p> 

Still need assistance?

If you need assistance, visit our website at www.infocus.com/support or call us. Check out our HOW TO section there for additional information on using this projector for home theater or gaming applications. See the Quick Start Poster/Booklet for support contact information.

This product is backed by a limited warranty. An extended warranty plan may be purchased from your dealer. When sending the projector in for repair, we recommend shipping the unit in its original packing material, or having a professional packaging company pack the unit. Please insure your shipment for its full value.

Using the remote control

The remote uses two (2) AA batteries (not provided). They are easily installed by removing the cover from the remote's back, aligning the + and - ends of the batteries, sliding them into place, and then replacing the cover.

Caution:

- When replacing the remote batteries, be aware that using batteries other than AA batteries may risk severe damage to the remote. When disposing of the batteries, be sure to do so in an environmentally proper manner.
- If the remote control gets wet, wipe it dry immediately.
- Avoid excessive heat and humidity.
- Ensure the batteries' polarity (+/-) is aligned correctly.
- Do not mix new and old batteries together, or mix different types of batteries together.
- Replace the batteries as soon as they run out.
- Remove batteries from the remote control when storing or not in use for a prolonged period.

To operate, point the remote at the front of the projector (not at the computer). The range of optimum operation is about 15 feet (4.5m).

Press the remote's **Power** button to turn the projector on and off (see page 12 for shutdown info).

Press the remote's **Menu** button to open the projector's menu system. Use the arrow buttons to navigate, and the **Select** button to select features and adjust values in the menus. See page 30 for more info on the menus.

The remote also has:

- **Volume** buttons to adjust the sound.
- **Custom** button that can be assigned to a special function, like Blank Screen or Freeze (see page 33).
- **Source** button brings up a menu of all possible sources allowing the user to switch the active source.
- **Blank** button to blank the screen.
- **Presets** button to select stored settings (see page 31).

- **Mute** button to silence the audio.
- **Auto Image** button to resynch the projector to the source.
- **Resize** button to switch among aspect ratios (see page 31).
- **Help** button to get help with connecting sources and improving the picture.

Troubleshooting the remote

- Make sure the batteries are installed in the proper orientation and are not dead.
- Make sure you're pointing the remote at the projector or the screen, not the computer, and are within the remote range of 15 feet (4.5m). For best results, point the remote at the projector.

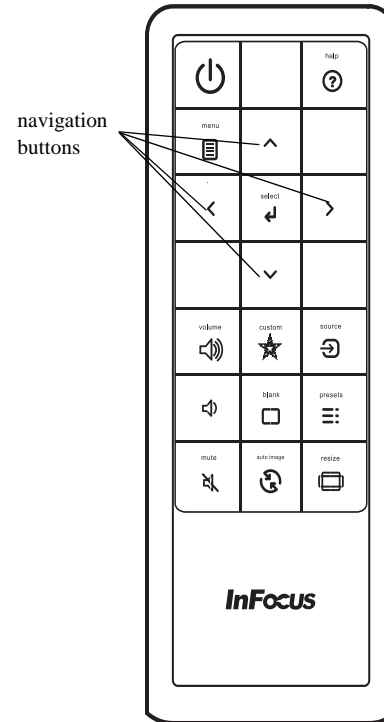

Using the audio

Using the projector's speakers

Connect the audio source to either the Audio 1 or Audio 2 connectors to hear audio through the projector speakers.

To assign the audio to a particular source, go to the Setup menu and choose the Audio Inputs feature. Defaults are as follows: Audio 1 is set to VGA 1 and VGA 2 with microphone, and Audio 2 is set to Composite with audio. See page 33 for details.

Amplified speakers may also be connected to the projector using the audio-out connector.

To adjust the volume, press the **Volume** buttons on the keypad or remote.

Troubleshooting Audio

If you aren't hearing the audio, check the following:

- Make sure the audio cable is connected to the Audio 1 or 2 connector on the projector, and that the other end of the cable is connected to an audio-out connector on the source (not a "line-in" or "microphone" connector).
- Make sure the volume is turned up enough. Press the **Volume** button on the keypad or remote.
- Make sure the correct source is active.
- Adjust the audio source.
- If playing a video, make sure the playback has not been paused.

connect audio cable

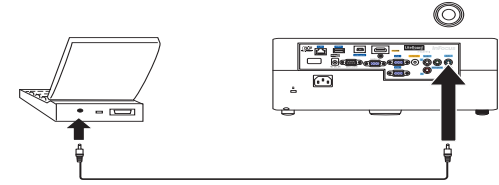

adjust volume

volume

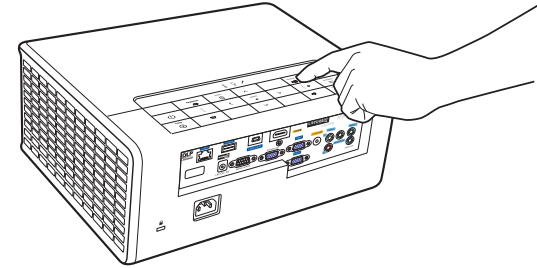

Playing sound through the projector

This projector is equipped with a 20-watt stereo speaker system, a dedicated microphone input, and advanced audio processing for superb audio performance.

External amplified speakers may also be connected using the audio-out connector on the projector.

This system has assignable audio. Audio 1, Audio 2 and/or the microphone can be assigned in any combination through the Audio Inputs feature described on page 33. **NOTE:** The microphone audio can be used alone (with other audio muted), or in conjunction with other audio simultaneously. The mixing of the microphone audio and other audio inputs is handled through the **Mic Volume** menu.

By default, Audio 1 plus microphone is associated with VGA 1 and VGA 2. Audio 2 plus microphone is associated with the Composite Video.

About the microphone input

- If you wish to use a microphone, connect a 3.5 mini jack cable Dynamic Microphone to the projector.
- You can use a wireless microphone as long as a wireless module is attached to the projector's microphone input jack and it works well with the associated devices. To ensure a quality use of the wireless microphone, it is recommended that your microphone conforms to the specifications listed in the table below.

Signal	Parameter	Min	Max	
Microphone	Transducer Principle			Dynamic
	Impedance	300	1K	ohm
	Frequency response	600	16k	Hz

- There are two ways to adjust the microphone volume.
 - Adjust the microphone volume level in the **Setup > Mic Volume** menu.
 - Press the **Volume** key on the keypad or remote to adjust the volume of the projector speaker and audio-out signal.
- The microphone will work regardless of whether the projector is turned on or soft-powered off, if the Always-On function "Microphone" is set to On.
- If the microphone is not working, check the volume setting and cable connection.

You might get feedback noise from the microphone when you are too close to the speaker of the projector. Move the microphone away from the speaker of the projector. The greater volume you require, the greater distance you need to be away from the speaker to prevent feedback noise.

NOTE: Only Dynamic Microphones should be used. Do not use active (phantom-powered) microphones as projector damage may occur.

Using the keypad buttons

Most buttons are described in detail in other sections, but here is an overview of their functions:

Power—turns the projector on and off (page 8).

Auto Image—resets the projector to the source (page 27).

Presets—cycles through the available preset settings (page 31).

Keystone—adjusts squareness of the image (page 9).

Menu—opens the on-screen menus (page 30).

Select—confirms choices made in the menus (page 30).

Up/Down/Left/Right arrows—navigates to and adjusts settings in the menus (page 30).

Volume—adjusts sound (page 25).

Source—brings up a menu with all possible sources, allowing the user to change the active source (page 8).

Help—accesses the projector’s help feature.

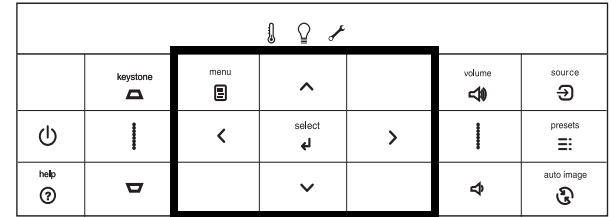

menu navigation buttons

Optimizing computer images

After the projector is running and the image is on the screen, you can optimize the image using the onscreen menus. For general information on using the menus, see page 30.

- Select default image settings using a preset appropriate to your environment.
- Adjust the Keystone, Contrast, or Brightness (page 31).
- Change the Aspect Ratio. Choose the option that best fits your input source (page 31).
- Adjust the Color Temperature (page 31).
- Adjust the Phase, Tracking, or Horizontal or Vertical position (page 32).
- Once you have optimized the image for a particular source, you can save the settings using Presets. This allows you to quickly recall these settings later (page 31).

Presentation features

Several features are provided to make giving presentations easier. Here is an overview, details are found in the menu section.

- The Custom key allows you to assign various features to the button. The default effect is Source Info, which displays information about the projector and current source. See page 33 for details.
- The Search Screen option lets you change the appearance of the blank screen and start up screen (page 34).
- Two options, Auto Off and Screen Save Time, are provided to automatically shut down the projector after several minutes of inactivity or display a black screen. This helps preserve lamp life (page 33).

Optimizing video images

After your video device is connected properly and the image is on the screen, you can optimize the image using the onscreen menus. For general information on using the menus, see page 30.

- Adjust the Keystone, Contrast, Brightness, Color, or Tint (page 31).
- Change the Aspect Ratio. Choose the option that best fits your input source (page 31).
- Select a Sharpness setting (page 31).
- Adjust the Color Temperature. Select a listed warmth value (page 32).
- Turn on Overscan to remove noise on the edges of the image (page 32).

Customizing the projector

You can customize the projector for your specific setup and needs. See page 33 to page 34 for details on these features.

- For rear projection, turn Rear Project on in the Setup menu.
- For ceiling mounted projection, turn Ceiling Mount on in the Setup menu.
- Specify which source the projector checks first for active video during power-up.
- Specify the function of the Custom key on the remote.
- Turn the projector's display messages on and off.
- Turn on power saving features.
- Specify appearance of blank screen and startup screen.
- Specify the language viewed on the menus.
- Save settings for the active source as a preset.

Dynamic Messaging

Using command codes, text messages can be sent for display by the projector (and all other InFocus projectors with the Dynamic Messaging feature) over a network or serial connection. Text is shown on top of whatever else is being displayed, and can be shown in ticker tape format or in a box, with optional beep tone alert. This is a great way to display urgent alert messages to employees, and simply requires a connection to the projector RS-232 serial control or LAN connector. Command codes for executing Dynamic Messaging are available on our website at www.infocus.com/support.

Using the menus

To open the menus, press the **Menu** button on the keypad or remote. (The menus automatically close after 60 seconds if no buttons are pressed.) Use the arrow buttons to move up and down to highlight the desired menu, then press the **Select** button.

To change a menu setting, highlight it, press **Select**, then use the up and down arrow buttons to adjust the value or select an option or turn the feature on or off. Press **Select** to confirm your changes. Use the arrows to navigate to another setting. When your adjustments are complete, press **Menu** to access a different menu; press the **Menu** button at any time to navigate to the higher-level menu and ultimately close the menu.

The menus are grouped by usage:

- The Basic Picture menu provides common image adjustments.
- The Advanced Picture menu provides more complex image adjustments.
- The Setup menu provides set-up type adjustments that are not changed often.
- The Status and Service menu provides information about the projector and source.

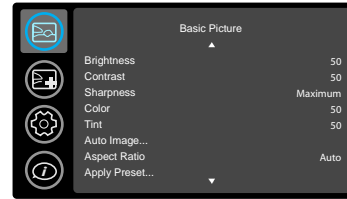
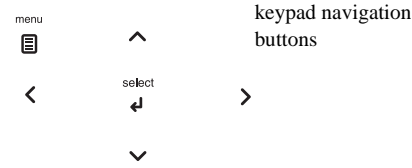

Basic Picture menu

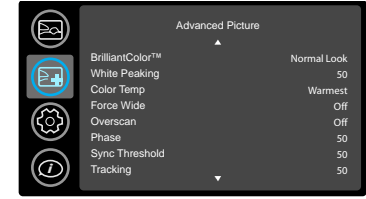

Advanced Picture menu

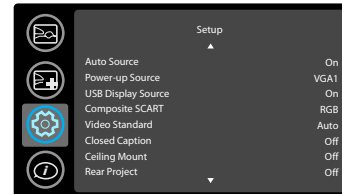

Setup menu

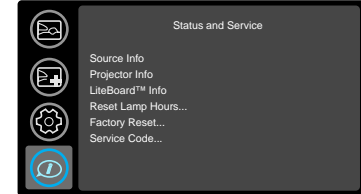

Status and Service menu

Basic Picture menu

To adjust the following settings, highlight the setting, press **Select**, use the up and down arrows to adjust the values, then press **Select** to confirm the changes.

Brightness: changes the intensity of the image.

Contrast: controls the degree of difference between the lightest and darkest parts of the picture and changes the amount of black and white in the image.

Sharpness: (video sources only) changes the clarity of the edges of a video image. Select a sharpness setting.

Color: adjusts a video image from black and white to fully saturated color. The color setting applies to video sources only.

Tint: adjusts the red-green color balance in the image of NTSC video images. The tint setting applies to NTSC video sources only.

Auto Image: resets the projector to the source.

Aspect Ratio: Aspect ratio is the ratio of the image width to image height. TV screens are usually 4:3. HDTV and most DVDs are 16:9.

Select Auto to have the projector choose the ratio. Choose Native to see the unmodified input with no resizing by the projector. Select 16:9 to watch enhanced widescreen DVDs.

For more information regarding Aspect Ratio, see page 10.

Apply Preset...: Presets are provided that optimize the projector for displaying computer presentations and video images under certain conditions.

There is also a user-definable preset. To set this preset, adjust the image and select Save User in the Presets menu. You can recall these settings in the future by selecting the User preset.

Keystone: adjusts the image vertically and makes a squarer image. You can also adjust keystone from the keypad.

Digital Zoom: reduces the size of projector's display area. If the display area has been resized by this setting, it can be moved by changing the **Horz Shift** and **Vert Shift** settings.

Horz Shift/Vert Shift: moves the display area horizontally or vertically if its size has been changed by the **Digital Zoom** setting.

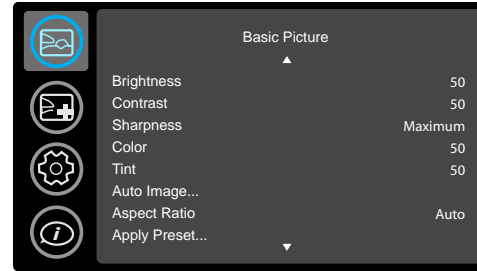

Basic Picture menu

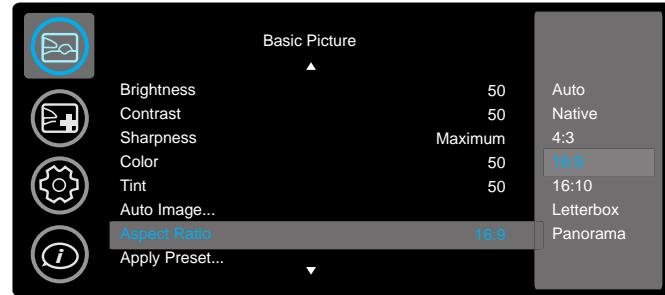

Aspect ratio

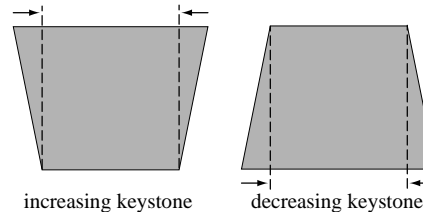

Advanced Picture menu

BrilliantColor™: produces an expanded on-screen color spectrum that delivers enhanced color saturation for bright, true-to-life images. Choose Normal Look for most video sources and Bright Look for most computer sources.

White Peaking: increases the brightness of whites that are near 100%.

Color Temperature: changes the intensity of the colors. Select a listed relative warmth value.

Force Wide: when this is off, the analog locking algorithms choose the standard mode resolution (4:3) as the preferred default resolution. When this is on, the analog locking algorithms choose wide mode resolution (16:10) as the preferred default resolution.

Overscan: removes noise around the video image.

Phase: adjusts the horizontal phase of a computer source.

Sync Threshold: (progressive signals only) If a hardware device, such as a DVD player, is not syncing properly with the projector, select this option to help it to sync when connected to the projector.

Tracking: adjusts the vertical scan of a computer source.

Color Space: applies to computer and component video sources. It allows you to select a color space that has been specifically tuned for the input signal. When Auto is selected, the projector automatically determines the standard. To choose a different setting, turn off Auto, then choose RGB for computer sources or choose either REC709 or REC601 for component video sources.

Noise Reduction: reduces temporal and/or spatial noise in the image.

Set Black Level...: analyzes the current input image and calculates an offset value which is then added to the analog to digital converter black level value. This ensures optimum black level for each analog source.

Detect Film: determines whether the original source of the input video was film (progressive) or video (interlaced).

3D Control: allows you to enjoy 3D (stereoscopic) content. Your IN3916 supports two synchronization modes (External Sync and DLP Link™) for controlling LCD shutter glasses. In addition to the projector, you will need a pair of 3D shutter glasses, 3D content, and 3D compatible source (and emitter). Ensure the glasses you choose are consistent with the synchronization mode you will be using. **Note:** Enabling 3D Control disables LiteBoard.

3D Sync Invert: (Only applies when 3D control is set to DLP Link™.) If the image appears to flutter, look odd or if the image depth looks off or you experience eye strain, turn this feature on to see if the image improves.

Gamma: select the appropriate gamma from among Video, Film, Bright, and CRT.

Red/Green/Blue Gain: adjusts the gain of the red, green or blue channel of the image.

Red/Green/Blue Offset: adjusts the offset of the red, green or blue channel of the image.

Horizontal/Vertical Position: adjusts the position of a computer source.

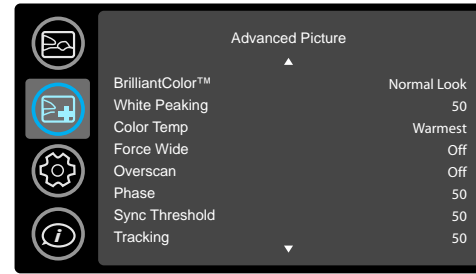

Advanced Picture menu

Setup menu

Language: allows you to select a language for the onscreen display.

Network: Allows you to setup network settings.

- **DHCP:** Turns the DHCP on or off.
- **IP Address:** Assign Network IP Address.
- **Subnet Mask:** Assign Network Subnet Mask.
- **Default Gateway:** Assign Network Default Gateway.
- **WINS Host Name Lookup:** Turns WINS Host Name Lookup on or off.
- **Host Name:** Displays the host name.
- **MAC Address:** Displays network MAC Address value.
- **Show Network Messages:** Turns network messages on or off. Network messages display the projector's IP address (and host name if enabled) when the projector is also displaying source messages.
- **Restart Network...:** Restarts the network.
- **Network Factory Reset...:** Performs factory reset.

LiteBoard™Wand: allows you to control the operation of the LiteBoard Wand.

Note: Enabling LiteBoard disables 3D Control.

Mic Volume: adjusts the relative volume of the microphone versus audio-in.

Key Click: turns the key click sound on or off. When this setting is on, pressing keys on the keypad causes the projector's speaker to play a "click" sound.

Custom Key: allows you to assign a different function to the Custom button, allowing you to quickly and easily use the effect. Highlight an effect and press **Select** to choose a different one.

- **Blank Screen:** displays an empty screen.
- **Mute:** turns off all sound.
- **Aspect Ratio:** toggles among 4:3, 16:9, 16:10, Native, Letterbox and Panorama options (see page 10 and page 31).
- **Source:** cycles through available sources.
- **Auto Image:** resets the projector to the source (page 27).
- **Freeze Screen:** pauses the projected image.
- **Source Info:** the default action. Shows the Source Info menu.
- **Projector Info:** shows the Projector Info menu.

- **Overscan:** removes noise around the image.
- **AV Mute:** enables or disables AV Mute function.
- **Closed Captions:** enables or disables Closed Captions.

Blank Key: select what to display when the blank key on the remote is pressed: your custom snapshot, a solid color screen (blue, black or white), the factory logo screen, a timer, or test patterns. The timer option is useful for classroom tests or break times during meetings.

Source Keys: Enables or disables Source Keys on the optional Commander-2 remote.

AC Power On: When this feature is on, the projector automatically turns on when electrical power is connected. This allows control of ceiling mounted projectors with a wall power switch.

Auto Off Time: automatically turns the projector off after no signals are detected for a preset number of minutes. If an active signal is received before the projector powers down, the image will be displayed.

Screen Save Time: automatically blanks the screen with a black color after no signals are detected for a preset number of minutes. The image returns when an active source is detected or a remote or keypad button is pressed.

Sleep Timer: Allows the projector to automatically power off after it has been on for a specified amount of time.

Always-On Functions: allows you to control which projector functions will work even when the projector is in standby (powered off but connected to AC Power). Press Up or Down to highlight the function you want to change, then press select or left and right to change the function to either Yes or No. Press menu when done. Note that some functions must always have the same value; in this case when you change one value, other values in the submenu may also change automatically. Functions which can be adjusted include: 5-Volt DC Output, Mic Input, Monitor Out, Network and USB Display.

Lamp Low Power: toggles between on and off. Turn it on to lower the light output of the lamp. This also lowers the fan speed, making the projector quieter.

Power Sounds: controls whether the projector makes a sound when powered on and off.

Internal Speaker: turns the internal speaker on or off.

Audio Inputs: assign an audio input to a specific video/computer source input. Press up or down to highlight the source you want to change, then press Select or

the left and right arrow keys to change the source's audio input. Press **Menu** when done changing audio inputs.

Auto Source: When this feature is On, the projector automatically finds the active source, checking the selected Power-up Source first. When this feature is Off, the projector defaults to the source selected in Power-up Source. To display another source, you must manually select one by pressing the **Source** button on the remote or keypad.

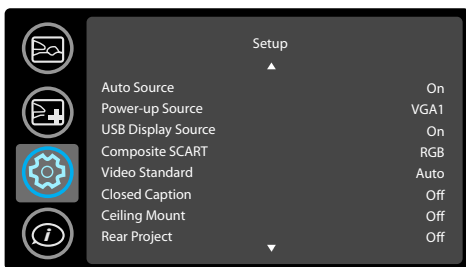

Setup menu

Power-up Source: determines which source the projector checks first for active video during power-up.

USB Display Source: when enabled, allows the USB mini-B to display images over USB.

Composite SCART: selects SCART connection type. This setting is only used for projectors where SCART can be connected to a single existing source (e.g. VGA), not on projectors where SCART must be connected to multiple sources (e.g. composite + component).

Video Standard: When this feature is set to Auto, the projector attempts to automatically pick the video standard based on the input signal it receives. (The video standard options may vary depending on your region of the world.) If the projector is unable to detect the correct standard, the colors may not look right or the image may appear “torn.” If this happens, manually select a video standard by selecting NTSC, PAL, or SECAM from the Video Standard menu.

Closed Captions (muted): controls closed caption display while audio is muted. If this setting is not off, and audio is muted, and the source is NTSC and contains

captions on the selected channel, then the projector must display caption text overlaid on the image.

Closed Captions (unmuted): controls closed caption display while audio is not muted. If this setting is not off, and audio is not muted, and the source is NTSC and contains captions on the selected channel, then the projector must display caption text overlaid on the image.

Ceiling Mount: turns the image upside down for ceiling-mounted projection.

Rear Project: reverses the image so you can project from behind a translucent screen.

Prevent PC Screen Saver: prevents your computer from going into Screen Save mode. The projector must be connected to the PC via a USB cable for this feature to work.

Search Screen: allows you to display a blank screen instead of the default screen at startup, and when no source is detected.

Take Snapshot...: captures the current image and allows it to be used as the search screen image.

Disable Snapshot: allows the user to disable the snapshot capability.

Show Messages: displays status messages (such as “Searching”) in the lower-left corner of the screen.

Menu Offset: allows you to change the position of the On Screen Display items.

Menu Transparency: allows you to change how much of the projected image behind the menu you can see. As the value increases, more of the image behind the menu is visible.

Magnify Controls: determines whether the select key can be used to change magnify settings when the OSD menu is not visible.

Keypad: enables or locks the projector keypad.

Glow Ring: controls the appearance of the optional glow ring status indicator.

PIN Protect: The PIN (personal identification number) feature allows you to password protect your projector. Once you enable the PIN feature, you must enter the PIN before you can project an image. The default PIN on this projector is

Menu-Source-Select-Up-Down. Use the navigation buttons on the remote or keypad to enter the correct 5-button press sequence. When all 5 numbers are entered correctly, press the **Select** button on the remote or keypad to select OK. If the message “Wrong PIN” appears, verify the code and re-enter it. If you mis-enter a

number, you must enter 5 numbers and press the **Select** button in order to access the “Wrong PIN” message and re-enter the code.

To enter the PIN at projector startup:

Power up the projector. The “Enter PIN” dialog box appears after the startup screen. Enter the PIN. Use the navigation buttons on the remote or keypad to enter the correct button press sequence. See the description above for instructions.

To change the PIN:

Select “Change PIN...” in the Setup menu. Enter the existing PIN. Enter the new PIN. You can navigate between OK and Cancel by pressing the up and down buttons on the keypad. Select OK or Cancel by pressing the **Select** button. Verify the new PIN.

If you lose or forget your custom PIN: Contact InFocus support. Go to www.infocus.com/support

Serial Port Baud Rate: selects the serial port and baud rate.

Serial Port Echo: controls whether the serial port echoes characters.

Status and Service menu

Source Info: a read-only display of current source settings.

Projector Info: a read-only display of current projector settings.

LiteBoard™ Info: a read-only display of current LiteBoard™ settings.

Reset Lamp Hours: resets the lamp hours used counter in the Projector Info menu to zero. Do this only after changing the lamp.

Factory Reset: restores all settings to their default.

Service Code: only used by authorized service personnel.

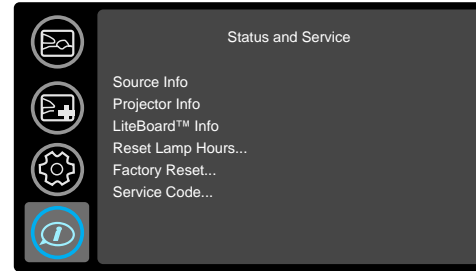

Status and Service menu

Using LitePort

LitePort displays a slide show of JPEG images stored on a USB flash drive connected to the projector or a Presentation To Go presentation. This can eliminate the need for a computer source. LitePort reads and displays files stored on a USB flash drive in either JPEG or Presentation-to-Go format (PtG). LitePort ignores all other file formats including PDF, BMP, TIFF, PNG, GIF, etc. which are not supported. (Note: Microsoft and others provide applications which convert PowerPoint presentations into a series of JPEG files.)

Displaying JPEG images

- 1 Connect a USB flash drive to your computer and copy JPEG files from your computer to the USB flash drive.
- 2 Turn on your projector if needed.
- 3 Remove the USB flash drive from your computer and plug it into the USB A connector on the rear of the projector.
- 4 The projector will display the LitePort menu.
- 5 Click **JPEG** and navigate to the desired image using the arrow buttons on the projector keypad or remote.
- 6 Click **Select** to display the desired image.
- 7 If multiple images exist in the same folder, the arrow buttons can be used to navigate through the images in alpha-numeric order. **NOTE:** The arrow buttons will not auto-scroll from the last image to the first image in the folder, nor will it auto-scroll from the first image to the last image in the folder.
- 8 To stop displaying the LitePort image, click the **Menu** button.



LitePort menu

Displaying PtG presentations

Follow these steps to show a slideshow presentation using Presentation-to-Go (PtG) presentation. This will preserve most PowerPoint embedded videos, transition effects, and animations. (Note: these instructions apply to PowerPoint 2007 in Windows; for other presentation programs refer to the presentation program's instructions or help file for the steps needed to save a presentation as separate JPEG files.)

To convert a PowerPoint presentation to a PtG presentation:

- 1 Download and install the PtG Converter software onto your computer (available on www.infocus.com/support).
- 2 Close all open computer applications.
- 3 Open the PtG Converter Lite program and click the **Convert** button.
- 4 Navigate to the desired PowerPoint presentation and click **OK** to begin conversion.
- 5 When the conversion is complete, a “Conversion Complete” message will display. Click **OK**.

To display the PtG presentation:

- 1 Connect a USB flash drive to your computer and copy PtG presentation from your computer to the USB flash drive.
- 2 Turn on your projector if needed.
- 3 Remove the USB flash drive from your computer and plug it into the USB A connector on the rear of the projector.
- 4 The projector will display the LitePort menu.
- 5 Click **PtG** and navigate to the desired presentation using the arrow buttons on the projector keypad or remote.
- 6 Click **Select** to display the desired presentation.

- 7 Use the arrow buttons to navigate through the presentation.

To stop displaying the presentation: click the **Menu** button.

Troubleshooting LitePort

- If images load slowly: Make sure you are using a newer USB 2.0-compatible (high speed) USB flash drive. Larger image file sizes may also slow down the player; to reduce file size, use an image editing program on your computer to resize images smaller; for the best balance between image quality and speed, resize images to be 1024 pixels wide.
- If no images are found, or some images are not shown, or you only see folder thumbnails but no images: Make sure that images are JPEG file type (file extensions .JPEG and .JPG); other file types are not supported and will be ignored.
- Using the Source button, make sure you have the LitePort source selected and make sure your USB flash drive is correctly and completely plugged in to the projectors LitePort connector.
- If nothing happens when you connect your USB flash drive, and you cannot select the LitePort input source as described above: Check the format of your USB storage device. LitePort only supports USB storage devices formatted as FAT32. Devices formatted as NTFS, and non-storage devices (such as cameras) are not supported.

LiteShow

The LiteShow Utility embedded in your projector provides many new features to make your presentations even more effective. Once installed, the Utility allows you to configure, control and display to your projector from a computer or PDA over either a wired or wireless LAN connection. It also allows you to display up to 4 computer screens simultaneously, and includes a moderator control, allowing you to control the display of up to 32 computers.

- Supports Windows 7, Vista, XP, 2000 and Mobile 5/6
- Supports Macintosh (Mac) version 10.4 and later
- Provides security login, wireless WEP/WPA key and Gatekeeper function to protect information from theft

LAN Connection

LiteShow supports wired and wireless LAN connectivity for projector control and display. There are three set-up options available.

- **Wired only:** projector can be accessed over the connected LAN
- **Wireless only:** projector creates a wireless LAN which can be accessed by 802.11b/g enabled computers.
- **Both wired and wireless:** projector creates a wireless LAN which can be accessed by 802.11b/g enabled computers and which also can provide an Access Point through the wired connection to the larger corporate network. Projector can be accessed through either ether wireless or wired network.

Setting up a LAN connection:

Select the LAN source on the projector which will display the LiteShow splash screen. Establish a network connection from your computer to the projector based on the wired and/or wireless set-up implemented when the projector was installed. Open a web-browser window and type the projector's IP address to connect to the projector's LiteShow Login screen.

LiteShow Login Screen



At the LiteShow Login screen, enter one of the following combinations to access associated LiteShow menus:

Login	Default Password	Menu Options
None	<i>Leave blank</i>	Download System Status
Basic User	trainer	Download System Status Basic Projector Control Moderator Control
Admin User	admin	Download System Status Basic Projector Control Moderator Control Admin Menu

If the default password listed above does not work, contact your IT administrator.

LiteShow Menu Options

Download

This menu allows the user to download the LiteShow Utility to their computer. Follow the Download LiteShow Utility instructions below.

System Status

This menu allows the user to review the network and connection status, and the source and projector information. This is particularly useful when troubleshooting.

Basic Projector Control

Note: To gain access to the Basic Menu, you must be logged in as a Basic or Admin User.

This menu allows the user to control many of the projector's Basic Picture and Setup OSD menu features through the network. These include: Power on/off, Brightness, Contrast, Sharpness, Color, Tint, Auto Image, Aspect Ratio, Apply Presets, Custom Key, Blank Key, source, AC Power, Internal Speakers, Audio Inputs, Volume, Mic Volume and Mute.

Moderator Control

Note: To gain access to the Moderator Control Menu, you must be logged in as a Basic or Admin User.

This menu allows the user to control who displays to the projector. **Note:** Up to 32 computers can be connected to the LiteShow network, however only four computers can be displayed simultaneously. See instructions below.

Admin Menu

Note: To gain access to the Admin Menu, you must be logged in as an Admin User.

Use the Admin Menu for configuring and controlling the projector via a web browser, setting up failure and warning alerts via email, managing the projector via SNMP.

Notes: Projector web pages and emails sent by the projector are always displayed in English language. Select the web pages language (English, Traditional Chinese, Simplified Chinese, Korean, German, French, Italian, Spanish, Polish, Swedish, Dutch, Portuguese, Russian, Finnish, Norwegian, Turkish, or Danish) on the home page. For network control, you can access the projector through Port 23 (Telnet). We use the same control codes on serial as we do over the network. InFocus network control uses the Telnet packet structure.

Network Setup: Before the LiteShow features can be used, the projector must be configured within this submenu for your network. Consult with your network administrator before entering information into this submenu. Incorrect network information may cause problems on your network. **Note:** To enable network functions at all times (even when the projector is powered off), the Network item in the Always-On Functions submenu in the Setup menu must be set to Yes (not No).

IP Setup: Wired LAN settings if DHCP is turned off or not available on the Wired LAN.

DHCP Server Setup: The projector acts as a DHCP host whenever hosting a Wireless LAN and/or whenever connected to a Wired LAN which doesn't include a DHCP Host.

Wireless Setup: IP configuration of the Wireless LAN – these control how the projector's Wireless LAN appears to computers on the Wireless network hosted by the projector.

GateKeeper: Client computers on the Wireless LAN can access the broader LAN/Internet over the Wired LAN connection if enabled here. Internet Only blocks IP addresses on the same LAN subnet as the projector, but allows access to other IP addresses.

CLI Pass-Through: The projector includes a basic Telnet engine. You can "Enable" an incoming Telnet connection in which the projector will parse and respond to CLI commands received on this port (23).

SNMP: Configure Simple Network Management Protocol settings.

Crestron Control System: Enable control by Crestron systems.

AMX Control System: Enable control by AMX systems.

Projection Setup: Select the LiteShow display resolution and set-up (or disable) login codes within this menu.

Change Passwords: Enter, confirm and apply new passwords for each Login type. Apply confirms and saves your modifications.

Reset to Default: Clicking the Reset to Default button restores factory default settings.

Advance Projector Control: Allows the user to control many of the projector's Advanced Picture OSD menu features through the network. These include: defaulted language, Auto-off Time, Low Power, Auto Source, Power Up Source, Closed Captions, Ceiling Mount, Rear Projection, Splash Screen, Magnify Controls, and Keypad, PIN and Serial Port controls.

Alert Settings: If your projector is connected to a network which supports Simple Mail Transfer Protocol (SMTP), you can configure it to alert you via email on significant events. Examples of possible event alert emails include lamp did not strike, lamp went out unexpectedly, fan failure, over-temperature, lamp hours.

Firmware Upgrade: The LiteShow Utility stored on the projector can be upgraded via the Firmware Upgrade option. When Firmware Upgrade>Upgrade has been selected, a warning message and count-down counter will be shown on the screen. A complete message will be shown on the screen within a few minutes. A projector restart will be required to complete the upgrade process.

Menu Sample: System Status menu

The screenshot displays the LiteShow System Status menu. The interface includes a navigation bar with 'LiteShow > System Status' and a 'Logout' button. A sidebar on the left contains 'Download' and 'System Status' options. The main content area is divided into several sections:

- Network Status:**

IP Address	192.168.3.90
Subnet Mask	255.255.255.0
Default Gateway	192.168.3.251
Wire MAC Address	00:11:22:33:44:55
- Connection Status:**

Projecting Status	Waiting for Projecting
Total Users	0
- Source Info:**

Active Source	LAN
Signal Format	Digital
Aspect Ratio	16:9
Resolution	1280 x 800
Vert. Refresh	0.36
Horz. Refresh	0.0
Pixel Clock	7.92
Sync. Type	Separate
Color Space	RGB
- Projector Information:**

Model Name	IN3916
Serial Number	A60
Native Resolution	1280 x 800
Firmware Version	0.0.4
Lamp Hours	151
Normal	120
Lower Power	31
Total Lamp Hours	152
Normal	121
Lower Power	31
Lamp Resets	1

Copyright © 2010 InFocus Corporation. All rights reserved.

Menu Sample: Basic Projector Control menu

LiteShow

LiteShow > Basic Projector Control Logout

Download

System Status

Basic Projector Control

Moderator Control

Power ON OFF

Basic Settings

Brightness

Contrast

Sharpness

Color

Tint

Aspect Ratio

Apply Preset

Notes

Custom Key

Blank Key

Source

AC Power ON OFF

Internal Speakers ON OFF

LAN

VGA1

VGA2

Audio Inputs

USB Display

HDMI

Composite

LitePort

Volume

Mic Volume

Mute ON OFF

Copyright © 2010 InFocus Corporation. All rights reserved.

Menu Sample: Admin > Network menu

LiteShow

LiteShow > Admin > Network Setup Logout

Network Setup

Projection Setup

Change Passwords

Reset to Default

Advanced Projector Control

Alert Setting

Firmware Upgrade

IP Setup

Obtain IP (DHCP) Use the following IP address

IP Address

Subnet Mask

Default Gateway

DNS Server

DHCP Server Setup

Auto Disable

Start IP

End IP

Subnet Mask

Default Gateway

DNS Server

Wireless Setup

Wireless LAN Enable Disable

Region

SSID

SSID Broadcast Enable Disable

Channel

Encryption

Key

Firewall All Pass All Block Internet Only

LAN Port Management Enable Disable

SysLocation

SysContact

Community Name

Control Panel System

IP Address

Port

System ID

DMZ Control System Enable Disable

Copyright © 2010 InFocus Corporation. All rights reserved.

Downloading the LiteShow Utility:

To begin projecting over the local network or wirelessly, the LiteShow Utility must be installed and running on your computer or PDA. This Utility is needed to manage the communication between your computer/PDA and the LAN-connected projector.

- 1 Turn the projector on, hit the Source button and select LAN. The LiteShow splash screen should appear within one minute.
- 2 You must be connected to the projector through a wired or wireless LAN. For wireless LAN, connect to the wireless network using the same SSID as shown on the projector.
- 3 Enter the IP address displayed on the projector into your web browser. (**Note:** The default IP address of LiteShow is 192.168.100.10)
- 4 Login as None and select Download.
- 5 Download and install the appropriate LiteShow application based on your operating system (Windows 7/Vista/XP/2000, Windows Mobile 5.0 or Macbook 10.4 and later).
- 6 Follow the Installation Wizard instructions.
- 7 Once the installation is complete, a LiteShow shortcut will be available on your desktop.

LiteShow Download menu

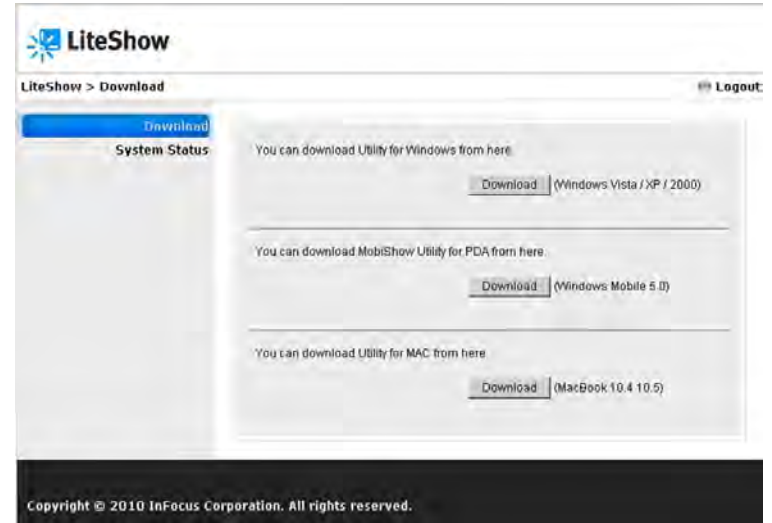

LiteShow Shortcut

To display your computer/PDA image over the LAN:

- 1 Turn the projector on, hit the Source button and select LAN. The LiteShow splash screen should appear within one minute.
- 2 You must be connected to the projector through a wired or wireless LAN. For wireless LAN, connect to the wireless network using the same SSID as shown on the projector.
- 3 Download and install the LiteShow Utility, if you have not already done so.
- 4 At the Access Point prompt, select the appropriate wireless connection to the projector or choose SKIP for a wired LAN connection.
- 5 Select the projector from the Device Name list.
- 6 Enter the Login Code, if prompted.
- 7 Begin presenting.

LiteShow Splash Screen



Access Point prompt

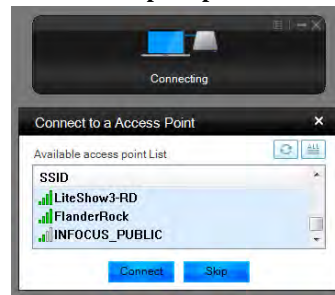

Device Name list



Login screen

To control the projected image:

Use the LiteShow Toolbar to switch between full screen projection and QuadView projection. You can also choose to refresh, pause or stop projecting. Various administration tools are also available through this control.

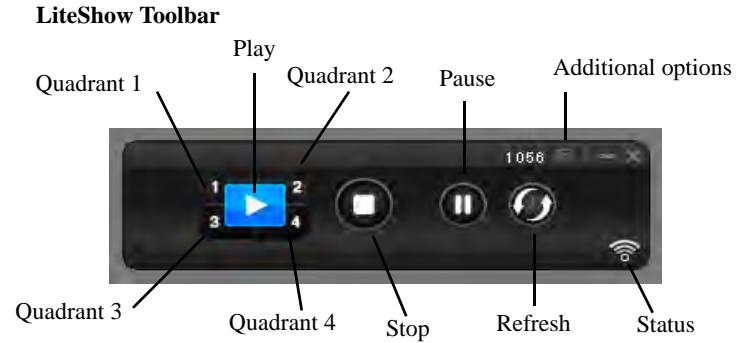

To moderate multiple users:

Note: You must be logged in as an Admin User to be able to control who is projecting.

From the Moderator Control menu, a list of users can be viewed. Using the Play Control buttons, choose one or more users (up to four simultaneously) to display. Choices include: Full display, Quadrant 1, Quadrant 2, Quadrant 3, Quadrant 4, or Stop (projecting).

LiteShow Moderator Control

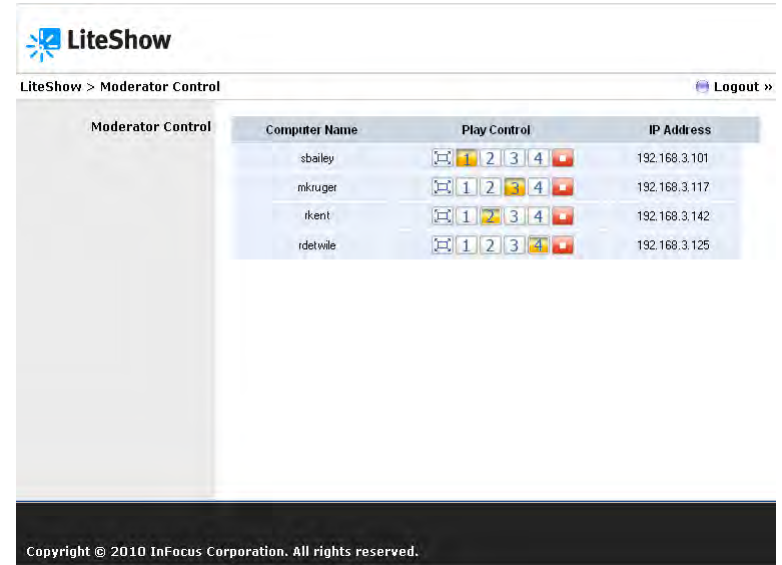

Maintenance

Cleaning the lens

- 1 Apply a non-abrasive camera lens cleaner to a soft, dry cloth.
 - Projector must be off and the lens must be at room temperature.
 - Avoid using an excessive amount of cleaner, and don't apply the cleaner directly to the lens. Abrasive cleaners, solvents or other harsh chemicals might scratch the lens.
- 2 Lightly wipe the cleaning cloth over the lens in a circular motion.

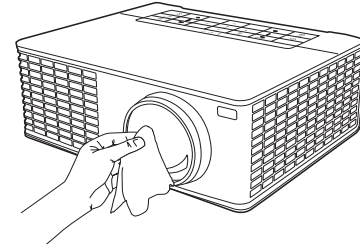

WARNINGS:

- Turn the projector off and unplug power cord before cleaning any part of the projector.
- Do not touch or block the projector lens with any objects as this can damage the projector lens. Use the lens cap when the projector is not in use and during transport. Scratches, gouges and other lens damage are not covered by the product warranty.
- Do not open any cover on the projector, except the lamp cover.
- Do not attempt to service this product yourself as opening and removing covers may expose you to dangerous voltage and other hazards. Refer all servicing to qualified service personnel.

Using the security lock

The projector has a security lock for use with a Cable Lock System. Refer to the information that came with the lock for instructions on how to use it.

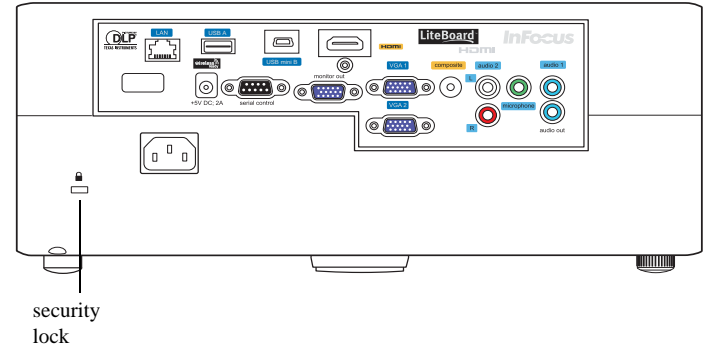

Replacing the projection lamp

The Lamp Hours timer in the Projector Info menu counts the number of hours the lamp has been in use. Twenty hours before the lamp life expires, the message “Replace lamp” appears on the screen at startup.

IMPORTANT NOTE:

- Always use the InFocus lamp module designed for your projector model. Look at the 8th character of the projector’s serial number (located on the bottom of the projector and in the Service and Support>Projector Info submenu).
- If the 8th character is a “0” (Example: BFQMyww0nnnn) Use SP-LAMP-062
- If the 8th character is an “A” (Example: BFQMywwAnnnn) Use SP-LAMP-062A
- **These lamps are NOT interchangeable, and are only designed to fit into compatible products.**
- Be sure to use the InFocus lamp module designed for this projector. You can order new lamps from www.infocus.com (in select areas), your retailer or your dealer. **Only genuine InFocus lamps are tested for use in this projector.** Use of non InFocus lamps may cause electrical shock and fire, and may void the projector warranty. InFocus is not liable for the performance, safety or certification of any other lamps.

WARNINGS:

- The projector uses a high-pressure mercury glass lamp. The lamp may fail prematurely, or it may rupture with a popping sound if jolted, scratched, or handled while hot. The risk of lamp failure or rupture also increases as the lamp age increases; please replace the lamp when you see the “Replace Lamp” message.
- To avoid burns, allow the projector to cool for at least 60 minutes before you replace the lamp.
- Unplug the power cord before replacing the lamp.
- Do not drop the lamp module. The glass may shatter and cause injury.
- Do not touch the glass surface of the lamp module. Fingerprints can obscure projection sharpness and may cause the glass to shatter.
- Be extremely careful when removing the lamp housing. In the unlikely event that the lamp ruptures, small glass fragments may be generated. The lamp

module is designed to contain most of these fragments, but use caution when removing it.

- Before replacing a ruptured lamp, clean the lamp compartment and dispose of cleaning materials. Wash hands after lamp replacement.
- When replacing the lamp while the projector is ceiling-mounted, wear protective eyewear to prevent eye injury.
- Hg – Lamp contains mercury. Manage in accordance with local disposal laws. See www.lamprecycle.org.

- 1 Turn off the projector and unplug the power cord.
- 2 Wait 60 minutes to allow the projector to cool thoroughly.
- 3 Remove the lamp door, located on top of the projector, by (a) removing the two screws on either side of the lamp door, (b) sliding the lamp door towards the front of the projector, and (c) tilting and lifting the door off.
- 4 Disconnect the lamp connector.
- 5 Loosen the captive screw that attaches the lamp housing to the projector.
NOTE: If the projector is installed on a ceiling mount, be careful not to drop the lamp module once the captive screw is loosened.
- 6 Carefully lift the lamp straight up, off of the alignment pins; being careful not to pinch the lamp connector. Dispose of the lamp in an environmentally proper manner.
- 7 Install the new lamp module, aligning the pins properly. Be careful not to pinch the lamp connector.
- 8 Tighten the screw. (**NOTE:** If the pins have not been aligned properly, the screw will not tighten securely.)
- 9 Re-attach the lamp connector to the projector.
- 10 Replace the lamp door by (a) aligning the hinges, (b) putting the lamp door down and (c) sliding it back into place.
- 11 Replace the lamp door screws and tighten securely.
- 12 Plug in the power cord and press the Power button to turn the projector back on.
- 13 To reset the lamp hour timer, navigate to the **Status and Service** menu and select **Reset Lamp Hours**. See page 36 for details.

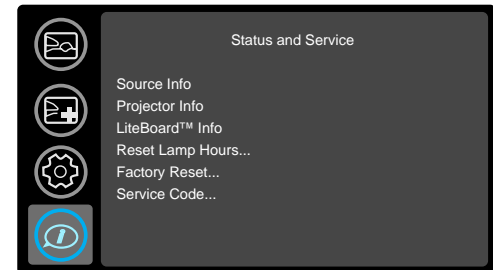
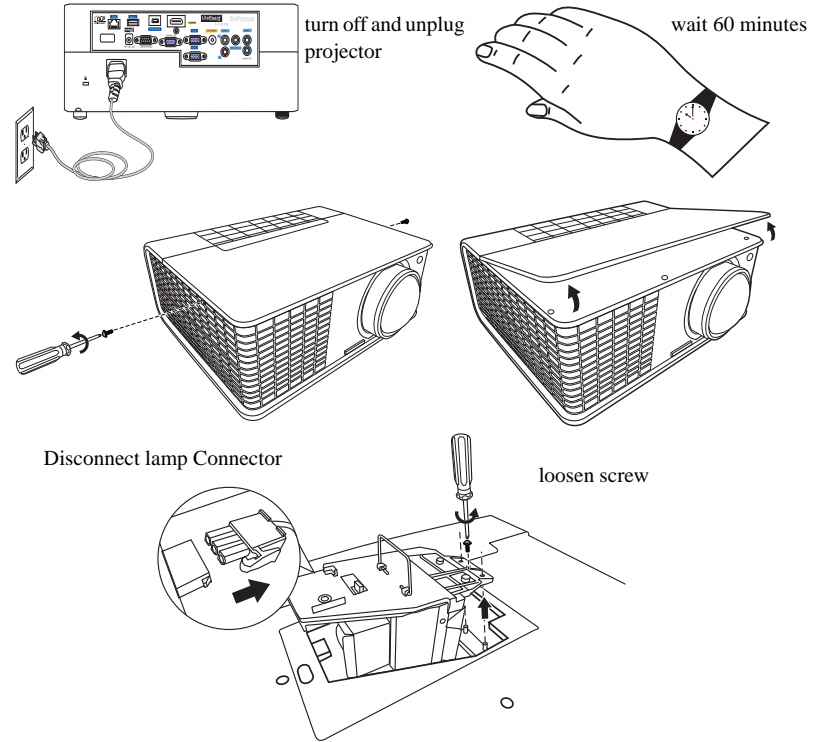

INDEX

Numerics

16x9 vs 4x3 11

3D Control 32

3D Sync Invert 32

A

AC Power On 33

Always-On Functions 33

Apply Preset 31

Aspect Ratio 11, 31

Audio In Computer connector 7

Audio Inputs 33

Auto Image 31

Auto Off Time 33

Auto Source 33

AV Mute 33

B

Battery Light 14

Blank Key 33

Blank Screen 33

Brightness 31

C

Cable Box 11

Ceiling Mount 34

Click Speed 14

Closed Captions 33, 34

Color Space 32

Computer In connector 7

Connecting

 Video device 11

Contacting InFocus 23

Contrast 31

Customer service contact information 23

D

Detect Film 32

Digital Zoom 31

Disable Snapshot 34

Display Image over LAN 44

Download LiteShow Utility 43

Dynamic Messaging 29

F

Factory Reset 36

Focus 9

Force Wide 32

Freeze Screen 33

G

Gamma 32

Glow Ring 34

H

HDTV 31

Horizontal Position 32

Horz Shift 31

I

Internal Radio 14

Internal Speaker 33

K

Key Click 33

Keypad 34, 27

Keystone 31

Keystone, Adjusting 9

L

Lamp Low Power 33

Lamp Replacement 47

Language 33

Lens Cleaning 46

Link Channel 14

Link Light 14

LiteBoard™ Info 36

LiteBoard™ Wand 33

LitePort 37

LiteShow 39

LiteShow Menu Options 40

LiteShow Moderator 40, 45

M

Magnify Controls 34

Menu Offset 34

Menu Transparency 34

Menu usage 30

Mic Volume 33

Motion 14

Mute 33

N

Noise Reduction 32

O

Overscan 32, 33

P

Phase 32

PIN Protect 34

Power connector 7

Power cord 7

Power Sounds 33

Prevent PC Screen Saver 34

Projector

- Connecting video devices 11

- Keypad buttons 27

- Menus 30

- Positioning 6

- Setting up 6

- Troubleshooting problems 16

Projector Info 33, 36

PtG Presentation 38

R

Rear Project 34

Red/Green/Blue Gain 32

Red/Green/Blue Offset 32

Remote control 24

Reset 36

Reset Button 14

Resetting the projector 36

S

Screen Aspect 11

Screen Save 16, 33

Scroll Wheel Mode 14

Search Screen 34

Security Lock 46

Sensor 14

Serial Port Baud Rate 35

Serial Port Echo 35

Service 36

Set Black Level... 32

Sharpness 31

Show Messages 34

Sleep Timer 33

Source 33

Source Info 33, 36

Source Key 33

Sync Threshold 32

T

Take Snapshot... 34

Tint 31

Tracking 32

Troubleshooting 16

TV tuner 11

U

Undo Button 14

USB 5, 7, 14

V

Vert Shift 31

Vertical Position 32

Volume button 25

W

Warranty 23